

Targis[®] System

Targis Control Unit

User Manual

UROLOGIX[®]

Patient Safety Summary

This patient safety summary is an overview of the key patient safety information provided in the Targis Control Unit User Manual. Please refer to the user manual to obtain all safety information pertaining to the use and operation of the Targis Control Unit.

- The treating physician should be present at all times during treatment.
- Perform an enema 1 to 2 hours before treatment or per physician instructions. An enema is mandatory.
- It is critical that, throughout the patient's treatment, the treating physician verify the correct position of the microwave catheter and the rectal unit. Patient safety is at risk if the following simple and straightforward safety check procedures are not correctly observed.

Safety Checks

1. Throughout the duration of the treatment, verify that the position mark on the catheter remains at a fixed distance from the penile meatus.
2. It is strongly recommended that at least every 5 - 10 minutes of the treatment, the correct position of the location balloon and the rectal unit is checked.
3. Always immediately check microwave catheter and rectal unit placement if the patient complains of any abnormal or sudden increase in pain. Pause the treatment if the patient complains of serious pain.
4. Observe the treatment parameters for sudden changes in readings, especially decreases in temperatures that might indicate a sensor has moved from its previous position.



Warnings

- The Cooled ThermoTherapy Procedure must not be initiated without assurance that the microwave catheter is properly positioned in the patient. **The correct positioning of the catheter must always be checked by ultrasound imaging prior to commencing treatment. Improper placement or orientation of the microwave catheter may lead to procedure failures or heating damage of non-target tissues such as the bladder neck, external sphincter, or penile urethra.**
- Do not under inflate or over inflate the microwave catheter balloon. Under inflation can cause the microwave antenna to be misplaced in the prostate, affecting the external sphincter or penile urethra. Over-inflation may result in balloon malfunction and possible improper positioning of the microwave antenna.
- The rectal unit must be positioned and inflated properly to ensure correct temperature sensing.

User Manual Overview

This manual combines technical reference material as well as user information on how to use the Targis Control Unit. The sections include these topics:



Notes: For information regarding the contents of this manual, please call Urologix Customer Service at 1-888-229-0772.

Read this manual before operating the Targis Control Unit and keep the manual in the holder on the unit for reference.

Section 1: System Description outlines Targis system components, equipment, subsystems, provides important notes about usage, describes the Targis Control Unit and the Targis Procedure Kit including the Microwave Catheter, Rectal Thermosensing Unit, Coolant Bag and accessories, presents information on installation, environment, sterilization, and cleaning procedures, connections, testing, and safety instructions.

Section 2: Treatment Setup describes how to set up the Control Unit, enter patient data, prepare the patient, prepare the coolant bag, and insert the Microwave Catheter and the RTU (rectal unit).

Section 3: Treatment Instructions discusses Targis System calibrations, how to adjust the coolant temperature and microwave power, how to begin and end treatment, and how to copy and print treatment data. The section ends with post-treatment options.

Section 4: Equipment Maintenance presents information on post-treatment cleaning procedures and storage instructions, describes correct moving and shipping methods and cautions, describes normal maintenance procedures that can be performed by the user organization. This chapter also itemizes equipment that is serviceable only by a Urologix trained service representative.

Section 5: Troubleshooting includes the Targis System specifications, a Troubleshooting Guide, Targis Treatment Screens, Description of Symbols, List of Figures and a Glossary.

Contents

Patient Safety Summary...	3
User Manual Overview...	4
Notice...	9
Safety Symbols and Definitions...	9
Precautions...	10
1.1 Introduction to the Targis System...	11
1.2 Targis System Equipment Overview...	11
1.2.1 Targis Control Unit...	12
1.2.2 Microwave Catheter...	13
1.2.3 Rectal Thermosensing Unit (RTU / RTU Plus)...	13
1.2.4 Coolant Bag...	14
1.2.5 Accessories...	14
1.3 Introduction to the Targis System Equipment...	15
1.4 Targis Control Unit...	15
1.4.1 Patient Connection Cable and Connector Housing...	16
1.4.2 Treatment Monitor...	16
1.4.3 Display Screen...	17
1.4.4 Soft Keys...	17
1.4.5 Keyboard...	17
1.4.6 Floppy Disk Drive...	17
1.4.7 Printer...	17
1.4.8 On/Off switch...	17
1.4.9 Lockable wheels...	17
1.4.10 Coolant System...	17
1.4.11 Chill Plate...	18
1.4.12 Temperature and Pressure Sensors...	18
1.4.13 Pump Mechanism...	18
1.5 Microwave Catheter (MDS)...	18
1.6 RTU / RTU Plus...	19
1.7 Coolant Bag...	20
1.8 Required Equipment...	21
1.8.1 Equipment Provided by Urologix...	21
1.8.2 Equipment Provided by the User...	21
1.9 Control Unit Installation and Use Environment...	22
1.10 Equipment Cleaning...	23
1.11 Equipment Connections...	23
1.12 Equipment Testing...	23
1.13 Safety Instructions...	23
Safety Precautions...	25
2.1 Targis Treatment Setup Introduction...	26
2.2 Prepare the Patient...	26
2.3 Prepare and Position the Targis Control Unit...	26
2.4 Power Requirements...	27
2.5 Turn on the Targis Control Unit...	27
2.6 Enter Patient Data...	28
2.7 Enter Clinical Data...	30
2.8 Prepare the Coolant Bag...	31
2.9 Insert the Microwave Catheter...	35
2.10 Preparing and Inserting the Single-Use Standard RTU...	37

2.11	Preparing and Inserting the RTU Plus with Reusable Handle...	39
2.12	Connect the MDS and RTU to the Control Unit...	41
3.1	Treatment Settings Screen...	45
3.1.1	Treatment Time...	45
3.1.2	Coolant Start...	45
3.1.3	Coolant Temp...	46
3.1.4	Cruise Ramp...	46
3.1.5	Ramp Rate...	46
3.2	Begin Calibration and Self-Test Cycle...	47
3.3	Calibration Progress Screen...	48
3.4	Treatment Procedure...	49
3.4.1	Treatment Screen Description...	49
3.4.1.1	Soft Key Icons...	50
3.4.1.2	Status Panel...	51
3.4.1.3	Control Panel...	52
3.4.1.4	10 Minute Graph...	53
3.4.1.5	60 Minute Graph...	53
3.4.1.6	Treatment Timers...	54
3.4.2	Control Panel Operation...	54
3.4.2.1	Control Panel: CRUISE CONTROL...	55
3.4.2.2	Control Panel: MANUAL CONTROL...	56
3.4.2.3	Control Panel: COOL CONTROLS...	57
3.4.2.4	Control Panel: MESSAGE...	58
3.4.2.5	Control Panel: ERROR/WARNING...	59
3.4.2.6	Control Panel: EXIT COOLDOWN...	59
3.4.3	Automatic Treatment - "Cruise II"...	60
3.4.3.1	Section: Ramp...	60
3.4.3.2	Section: Treatment...	61
3.4.3.3	Section: If an Error/Warning occurs, read the message and respond according...	61
3.4.3.4	Section: Cooldown...	61
3.4.4	Manual Treatment - Express Protocol...	61
3.4.4.1	Section: Ramp...	61
3.4.4.2	Section: Treatment...	62
3.4.4.3	Section: Cooldown...	62
3.5	Terminate Treatment...	63
3.6	Post-Procedure Treatment Options...	64
3.7	Options...	64
3.7.1	Copy File to Diskette...	65
3.7.2	Print to File...	66
3.7.3	Format Diskette in Floppy Drive...	67
3.7.4	Adjust System Settings...	68
3.7.4.1	Set Control Unit Time and Date...	69
3.7.4.2	Select a Language...	70
3.7.5	Option Errors...	70
3.8	MW OFF Soft Key...	70
3.9	Targis System Errors...	71
3.9.1	Calibration Errors...	71
3.9.2	Treatment Errors...	72
3.9.3	System Halt Errors...	72
4.1	Post-Treatment Cleaning Procedures...	75
	Storage Instructions...	76

4.2.	Equipment Moving Instructions...	76
	Observing Proper Safeguards...	76
	Equipment Shipping Instructions...	76
4.3	Operator Inspection...	77
	Daily Maintenance...	77
	Periodic Maintenance...	77
4.4	Printer Maintenance...	77
4.4.1	Changing Paper in Printer...	77
4.4.2	Printer Cleaning. ...	78
4.5	Fuse Replacement...	78
4.6	Targis Control Unit Power Cords...	80
4.7	Targis Control Unit Specifications...	81
5.1.	Troubleshooting Guide...	83
5.2	Targis Treatment Screens...	98
5.3	Description of Symbols...	97
5.4.	Glossary...	100
5.5	Electromagnetic Compatibility (EMC) Tables...	108

List of Figures:

Section 1

Figure 1-1	Targis Control Unit...	12
Figure 1-2:	CTC Advance Microwave Catheter...	13
Figure 1-3:	Single Use Rectal Thermosensing Unit (RTU)...	14
Figure 1-4:	Assembled RTU Plus...	14
Figure 1-5:	Coolant Bag...	14
Figure 1-6:	Targis Control Unit...	15
Figure 1-7:	Patient Connection Cable...	16
Figure 1-8:	Treatment Monitor Features...	16
Figure 1-9:	Coolant System Features...	18
Figure 1-10:	MDS Features...	19
Figure 1-10a:	RTU Features...	19
Figure 1-10b:	Assembled RTU Plus Features...	20
Figure 1-11:	Coolant Bag Features...	20
Figure 1-12:	Targis Control Unit Rear Cover...	23

Section 2

Figure 2-1:	Startup Display Screen...	27
Figure 2-2:	Main Menu Screen...	28
Figure 2-3:	Patient Data Display Screen...	29
Figure 2-4:	Clinical Data Screen...	30
Figure 2-5:	Filling the Coolant Bag...	31
Figure 2-6:	Positioning the Coolant Bag on the Top Mounting Pins...	32
Figure 2-7:	Positioning the Coolant Bag onto the Lower Mounting Pin...	32
Figure 2-8:	Coolant System with Pump Mechanism Open...	33
Figure 2-9:	Positioning the Sensor Module...	34
Figure 2-10.	Coolant System with Pump Closed...	34
Figure 2-11a:	Targis MDS...	36
Figure 2-11b:	CTC Advance MDS...	36

Figure 2-12. Inserted MDS and Single Use RTU...37
Figure 2-13. Standard RTU...38
Figure 2-14. RTU Plus Reusable Handle...39
Figure 2-15. RTU Plus Disposable Balloon...39
Figure 2-16. Inserting the Temperature Sensor Strip...40
Figure 2-17. Proper Positioning of the Temperature Sensor Strip...40
Figure 2-18: Connected MDS and RTU...42
Figure 2-19: Patient connection Cable...43

Section 3

Figure 3-1: Treatment Setting Screen...45
Figure 3-2: Treatment Checklist Screen...47
Figure 3-3: Calibration Progress Screen...48
Figure 3-4: Treatment Screen...50
Figure 3-5: Soft Icon Keys...50
Figure 3-6: Status Panel...51
Figure 3-7: Control Panels...52
Figure 3-8: 10 Minute View...53
Figure 3-9: 60 Minute View...53
Figure 3-10: Treatment Timers...54
Figure 3-11: Cruise Control Screen...55
Figure 3-12: Manual Control Screen...56
Figure 3-13: Cool Control Screen...57
Figure 3-14: Message Panel...58
Figure 3-15: Error/Warning Panel...58
Figure 3-16: Exit Cooldown Panel...59
Figure 3-17: Options Screen...64
Figure 3-18: Floppy Disk Drive...65
Figure 3-19: Select File Pop-up Screen...65
Figure 3-20: Confirm Operation Pop-up Screen...66
Figure 3-21: Treatment Printout...67
Figure 3-22: Confirm Format Disk Pop-up Screen...68
Figure 3-23: Formatting Disk Pop-up Screen...68
Figure 3-24: Systems Setting Screen...68
Figure 3-25: Set Date and Time Pop-up Screen...69
Figure 3-26: Set Time Pop-up Screen...69
Figure 3-27: Set Date Pop-up Screen...69
Figure 3-28: Select Language Screen...70
Figure 3-29: Options Error Pop-up Screen...70
Figure 3-30: Calibration Halted Screen...71
Figure 3-31: Treatment Error Message Panel...72
Figure 3-32: System Halt Screen...73

Section 4

Figure 4-1. Internal Coolant Level Indicator...77
Figure 4-2: Loading Paper in the Printer...78
Figure 4-3: Targis Control Unit Rear Cover...79

Notice

The information contained in this manual is subject to change. This manual does not purport to address all safety concerns associated with the Urologix Targis Control Unit.





The user must establish appropriate safety and health practices.

The Targis Control Unit is intended for use only by qualified medical personnel. Federal (U.S.A) law restricts this device to sale by or on the order of a physician trained and/or experienced in the use of this device as outlined in the required training program.

Medical equipment, however sophisticated, should never be a substitute for the human care, attention, and critical judgment that only trained healthcare professionals can provide.

Safety Symbols and Definitions

The following safety symbols are used throughout this manual. Familiarize yourself with each symbol and its meaning before using this equipment. You can find additional symbols associated with the Targis Control Unit in Section 5.3 Description of Symbols.

Safety Symbol	Definition
 Note	A note indicates important information that helps you operate the Targis Control Unit or use the disposable devices.
 Caution	A caution contains instructions that must be followed to avoid a possible malfunction of or damage to the equipment or its connected devices. Do not proceed beyond a caution sign until the indicated conditions are fully understood and met.
 Warning	A warning contains important information about possible danger to you or the patient. Do not proceed beyond a warning sign until the indicated conditions are fully understood and met.
 Instruction Manual	The instruction manual symbol is displayed on the product when it is necessary for you to refer to the Targis Control Unit User Manual (this document).

Precautions

Only those physicians who have been thoroughly trained on the operation of the Targis System and the Cooled ThermoTherapy Procedure should deliver the treatment.

The Cooled ThermoTherapy Procedure must not be initiated without assurance that the Microwave Catheter is properly positioned in the patient. **The correct positioning of the Microwave Catheter must always be checked by ultrasound imaging prior to commencing treatment. Improper placement or orientation of the microwave catheter may lead to procedure failures or heating damage of non-target tissues such as the bladder neck, external sphincter, or penile urethra.**

All components of the Targis Control Unit must be used in a manner consistent with the instructions set forth in their respective Instructions for Use insert and the Targis Control Unit User Manual (this document). Failure to do so may result in insufficient treatment or increased risk of injury or infection to the patient.

 **Note:** Use of the Targis Control Unit results in the deposition of microwave energy in the patient's prostate and in adjacent regions of the body. Some animal studies in the literature suggest that there may be as yet unknown health effects from exposure to microwave radiation, including an increased incidence of tumors. Although it is not possible to extrapolate these studies to humans, they suggest that unnecessary microwave radiation exposure should be avoided.

At least 20 cm of ventilation clearance must be provided around the base of the Targis Control Unit.

 **Note:** This equipment has been tested and found to comply with the limits for a Class A digital device, pursuant to part 15 of the Federal Communication Commission (FCC) Rules. These limits are designed to provide reasonable protection against harmful interference when the equipment is operated in a commercial environment. This equipment generates, uses, and can radiate radio frequency energy and, if not installed and used in accordance with the instruction manual, may cause harmful interference to radio communications. Operation of this equipment in a residential area is likely to cause harmful interference, in which case the user will be required to correct the interference at his own expense.

The Urologix Targis Control Unit emits a small amount of electromagnetic energy during a procedure. Urologix recommends that all electronic medical devices be kept at a minimum distance of 1.0 meter from the Targis Control Unit when performing a treatment. However, a 1-meter separation of electronic medical equipment from the Targis Control Unit does not guarantee that operation of other devices will not be impacted. The effect of this electromagnetic energy on all equipment cannot be predicted due to age and quality of maintenance. The performance of each piece of equipment operated near the Targis Control Unit, during a procedure, must be evaluated for degradation. For more detailed EMC requirements, refer to Section 5.5 Electromagnetic Compatibility (EMC) Tables in the Appendix.

Since microwave energy can travel through walls, ceilings, and floors to affect other devices, it is important to understand that the 1-meter safety distance applies not only to the treatment room, but also to all adjacent rooms in the building, including the rooms above and below the treatment room. Do not operate the Targis Control Unit near equipment that emits electromagnetic energy, unless the effect on the Targis Control Unit has been evaluated and no degradation of performance was found. The national standard ANSI/IEEE C95.1 - 1999 Edition (Safety Levels with Respect to Human Exposure to Radio Frequency Electromagnetic Fields) recommends a maximum stray field exposure level for whole body exposure of 3 mW/cm^2 , as averaged for any 6 minute period. The maximum radiated field, at full power, from the Targis Control Unit patient cable and Microwave Catheter, at 5 centimeters, is 2.1 mW/cm^2 . Urologix recommends that the operator maintain a minimum distance of 5 centimeters from the patient cable and exposed portions of the Microwave Catheter during the procedure.

Operate the Targis Control Unit and connected devices only when connected to a fully tested, hospital grade power outlet with adequate grounding.

The Targis Control Unit must be plugged into the appropriate voltage outlet.

The electrical equipment inside the Targis Control Unit uses voltages capable of causing serious injury or death from electric shock. To avoid this hazard, never open the housing of the Targis Control Unit.

1.1 Introduction to the Targis System

The Targis Control Unit treats Benign Prostatic Hyperplasia (BPH) by applying microwave power to the prostate and continuously heating the diseased tissue via the Microwave Catheter. It also minimizes patient discomfort and risk to the urethra by circulating cooling fluid through the Microwave Catheter. Rectal wall damage is prevented by preferential targeted heating of the prostate with the Targis Microwave Catheters. Qualified medical personnel are able to continually monitor the Microwave Catheter and rectal temperatures. If these temperatures indicate that a protocol parameter may be exceeded, the operator can adjust the microwave power to protect the urethra or rectal wall from overheating.

1.2 Targis System Equipment Overview

The products to be described in this manual comprise the Targis System which includes the Control Unit, Procedure Kit (comprised of a Microwave Catheter, a Rectal Thermosensing Unit, and a Coolant Bag), and accessories. The Targis System equipment overview is as follows:

1.2.1 Targis Control Unit

The Targis Control Unit provides the user with interface for entering patient data, controlling treatment parameters (for microwave power, coolant temperature, and time), and monitoring rectal and Microwave Catheter temperatures. (*figure 1-1*)

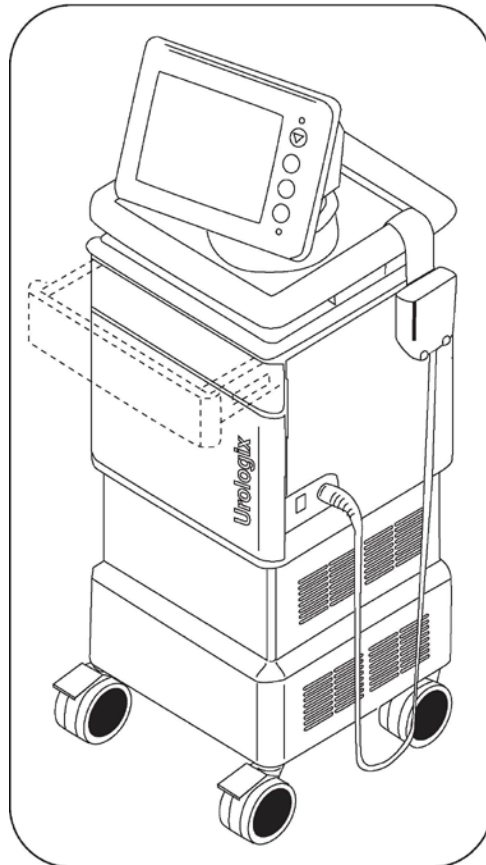

Figure 1-1: Targis Control Unit

The Control Unit supplies microwave energy and coolant to the Microwave Catheter, and collects temperature data from the Microwave Catheter and the Rectal Thermosensing Unit.

1.2.2 Microwave Catheter

The Targis Microwave Catheter (MDS), the Cooled ThermoCath MDS and the CTC Advance MDS contain a microwave antenna and cable, a distal balloon to position the device at the bladder neck, optical-fiber temperature sensor to measure urethral temperatures, a urine drainage port, and lumens to circulate sterile water to cool the urethra (*figure 1-2*). The CTC Advance MDS is shown in Figure 1-2 for reference.

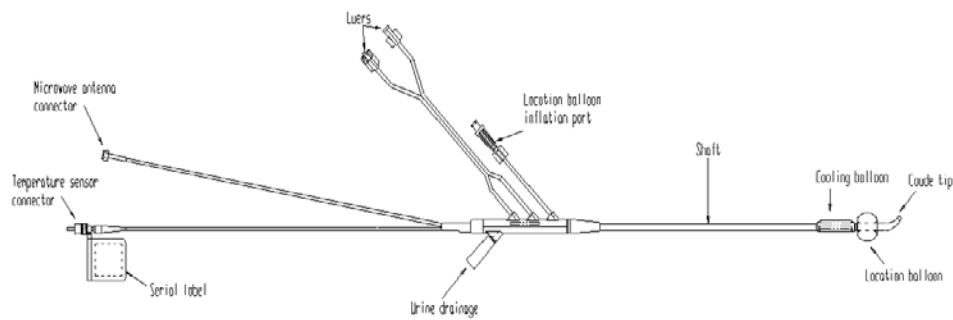

Figure 1-2: CTC Advance Microwave Catheter

1.2.3 Rectal Thermosensing Unit (RTU / RTU Plus)

The Targis Control Unit requires the use of either the single-use RTU or the RTU Plus with reusable handle and single-use balloon. The standard RTU and RTU Plus both consist of an inflatable balloon with 5 temperature sensors that is placed in the rectum to monitor rectal temperature along the anterior-rectal wall during treatment. The RTU (*figure 1-3*), is a single use device. The RTU Plus (*figure 1-4*), employs a reusable handle that is coupled with a single use balloon.

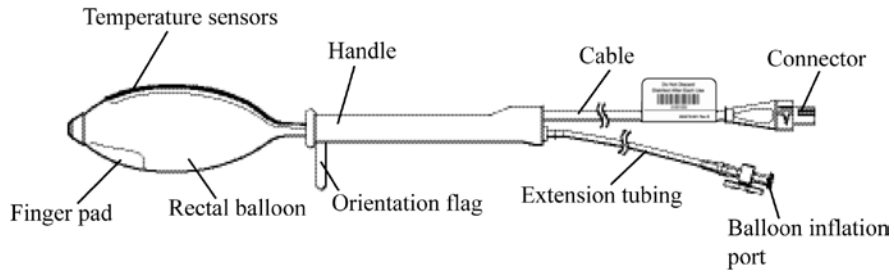

Figure 1-3: Single Use Rectal Thermosensing Unit (RTU)

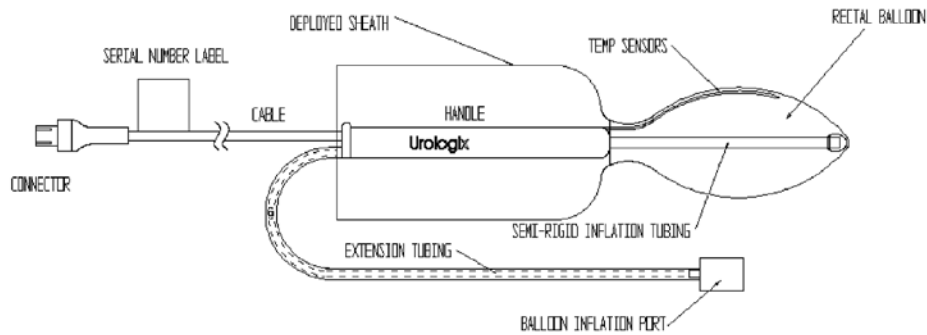

Figure 1-4: Assembled RTU Plus (with reusable handle and single use balloon)

1.2.4 Coolant Bag

The single-use Coolant Bag (*figure 1-5*) serves as the reservoir for the sterile water and during treatment is placed in the Control Unit on the chill plate. Tubing from the Coolant Bag is connected to the MDS. The sterile water is chilled and circulated through the MDS by the Control Unit to protect the urethra from the heat generated by the MDS.

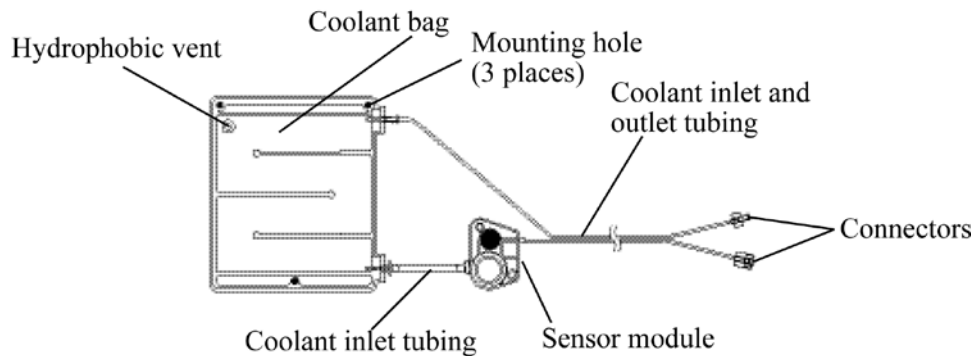

Figure 1-5: Coolant Bag

1.2.5 Accessories

Several accessories accompany the Targis System. They are:
 Targis System: Targis Control Unit User Manual.
 Control Unit Dust Cover.

Patient Comfort Kit containing 2 Knee Cushions and the MDS Holder.
An optional Transport Kit containing a Trolley, Protective Cover and Electrical Safety Tester.

1.3 Introduction to the Targis System Equipment

This section further describes the Targis System equipment:

- Control Unit
- Microwave Catheter (MDS)
- Rectal Thermosensing Unit (RTU)
- Coolant Bag

1.4 Targis Control Unit

The Targis Control Unit houses several components that apply microwave power, monitor temperatures and maintain coolant circulation during the Cooled Thermotherapy Procedure. In addition, the Control Unit displays procedure information to the user.

The Control Unit includes these features (*figure 1-6*):

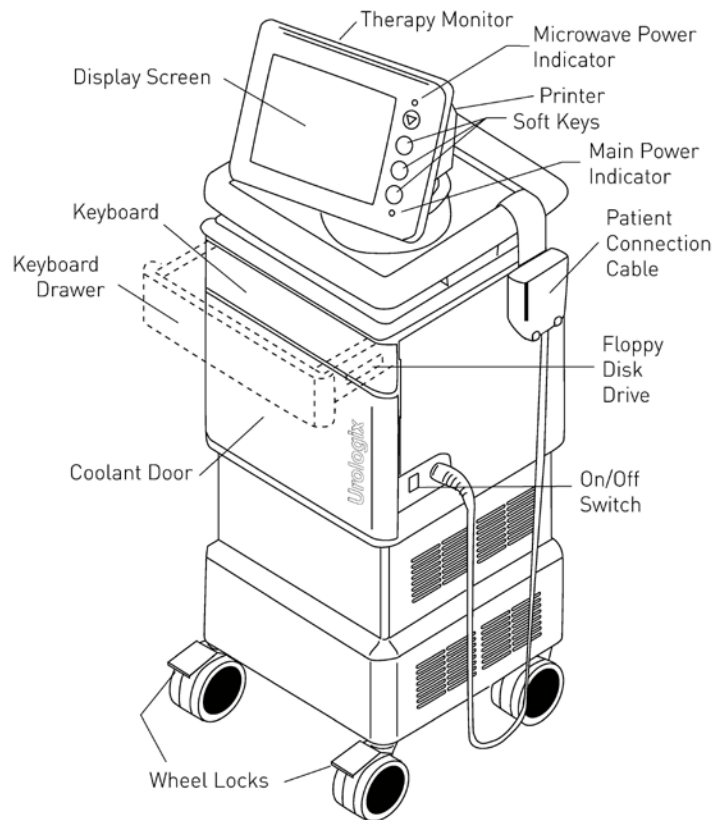

Figure 1-6: Targis Control Unit

1.4.1 Patient Connection Cable and Connector Housing

Data from the Targis MDS and the RTU / RTU Plus enter the Control Unit via the Patient Connection Cable (*figure 1-6 and 1-7*).

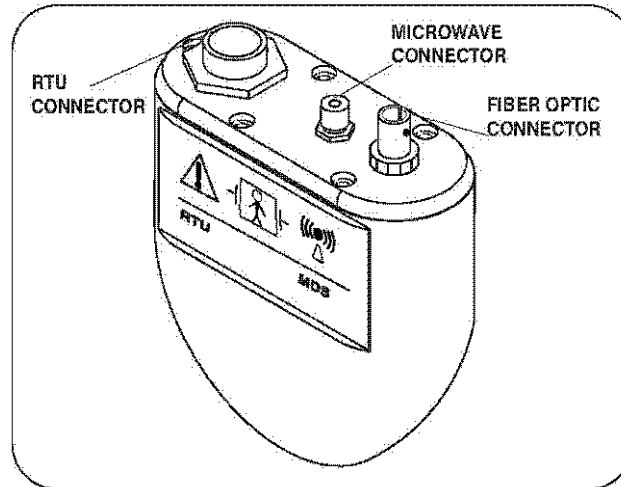

Figure 1-7: Patient Connection Cable

The Patient Connection Cable contains connectors for the RTU / RTU Plus, fiber optic and microwave connectors.

1.4.2 Treatment Monitor

The monitor houses the display and soft keys (*figure 1-8*). It can be tilted or swiveled for improved viewing.

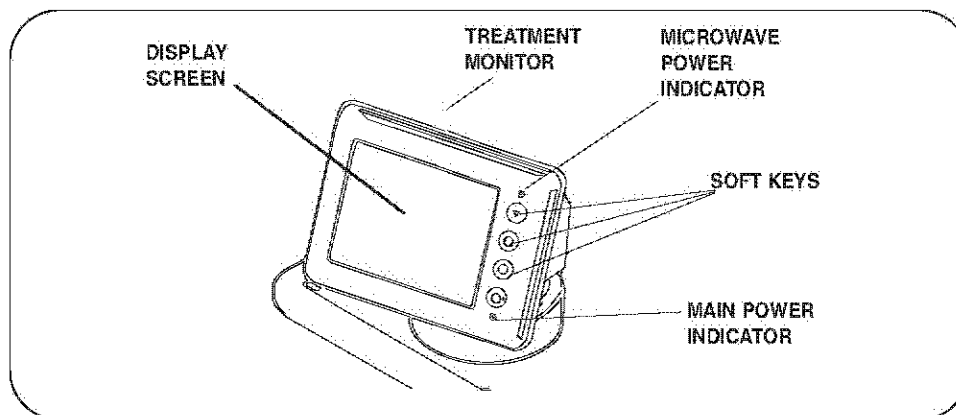

Figure 1-8: Treatment Monitor Features

1.4.3 Display Screen

The display screen (*figure 1-8*) allows you to monitor the treatment session and when necessary enter patient data, adjust the coolant temperature, adjust the microwave power and turn the coolant pump on or off.

1.4.4 Soft Keys

Soft keys (*figure 1-8*) provide you with the ability to operate the Targis Control Unit. They allow you to toggle through software screens and adjust settings.

1.4.5 Keyboard

Stored within the Targis Control Unit body, the keyboard (*figure 1-6*) allows you to enter and store patient data. The keys are sealed to prevent internal damage from spillage onto the keyboard.

To access the keyboard, grasp the sides of the keyboard door and pull the keyboard towards you.

1.4.6 Floppy Disk Drive

You can store patient data on a floppy disk by using the floppy disk drive (*figure 1-6*). This drive is designed to copy data to 1.44 MB, 3.5 inch, DOS formatted floppy disks.

1.4.7 Printer

You can print the data from any treatment using the printer. The printer is a 4-inch thermal printer and uses paper provided by Urologix.

1.4.8 On/Off switch

Turn the Targis Control Unit on or off with this switch (*figure 1-6*).

1.4.9 Lockable wheels

The Targis Control Unit can be made stationary by locking the front wheels (*figure 1-6*).

To lock the wheels, use your foot to press down on the front part of the wheel lock tab. To unlock the wheels, press on the back part of the wheel lock tab.



Manual: Read the Targis System: Targis Control Unit User Manual before turning on and operating the system.

1.4.10 Coolant System

The coolant system consists of these components: chill plate, temperature and pressure sensors, peristaltic pump mechanism, coolant door, and Coolant Bag (*figure 1-9*).

1.4.11 Chill Plate

The chill plate is located behind the coolant door on the front of the Targis Control Unit (*figure 1-9*). The chill plate is equipped with mounting pins that hold the Coolant Bag securely against the chill plate surface.

As coolant returns from the MDS outlet tubing, it circulates through the Coolant Bag, and transfers heat to the chill plate, which in turn chills the fluid and re-circulates it through the MDS.

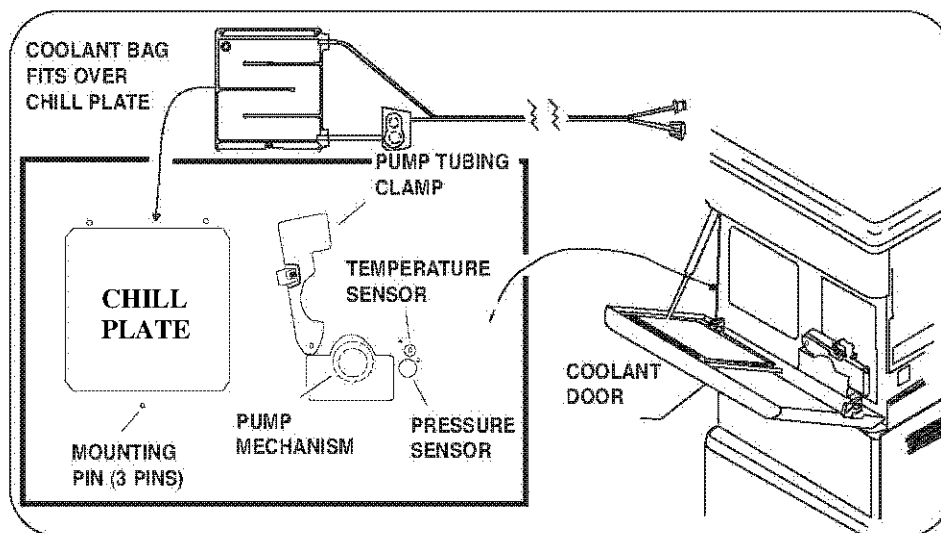

Figure 1-9: Coolant System Features

1.4.12 Temperature and Pressure Sensors

Temperature and pressure sensors located on the Control Unit monitor the coolant temperature and the coolant pressure (*figure 1-9*). This monitoring ensures that the coolant temperature is maintained at acceptable limits and that the coolant circulates properly.

1.4.13 Pump Mechanism

Coolant is circulated by the pump mechanism (*figure 1-9*). The inlet coolant tubing runs across a peristaltic pump which pushes the coolant through the tubing and MDS and back into the Coolant Bag.

1.5 Microwave Catheter (MDS)

The single use MDS contains all of the features shown in Figure 1-10. The CTC Advance MDS is depicted in Figure 1-10 for reference. The MDS is used for:

- Delivering microwave energy to the targeted prostatic tissue*
- Monitoring the urethra temperature*
- Cooling the urethra during treatment*
- Draining urine during treatment*

The microwave antenna and temperature sensor are connected to the Control Unit via the patient connection cable. To ensure that the MDS is positioned properly within the urethra, the clinician inflates the location balloon in the bladder to hold the MDS in place during treatment.

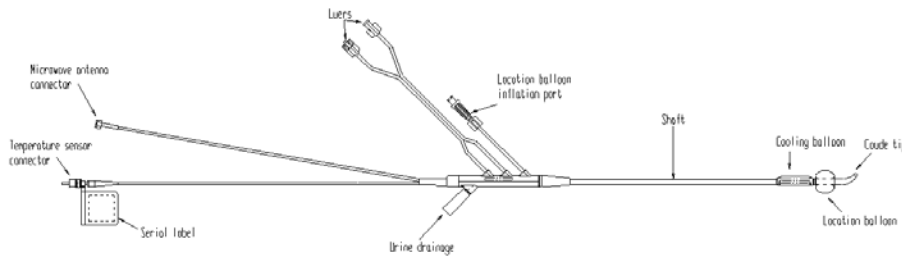

Figure 1-10: MDS Features

The MDS also includes:

- A urine drainage port that connects to a standard drainage bag*
- Luer connectors that attach to the Coolant Bag*

Caution: The microwave antenna on the distal end of the MDS may break if you bend it. Do not grab the MDS and squeeze it in the area of the antenna or the shaft. The optical fiber located in the flexible MDS shaft may be broken if it is clamped.

1.6 RTU / RTU Plus

The RTU / RTU Plus (figures 1-10a and 1-10b) contain sensors that monitor rectal temperature and send this information to the Control Unit during treatment. Once the clinician inserts the RTU / RTU Plus into the rectum, he or she inflates the RTU balloon with air to hold the thermosensors in place against the prostatic wall of the rectum.

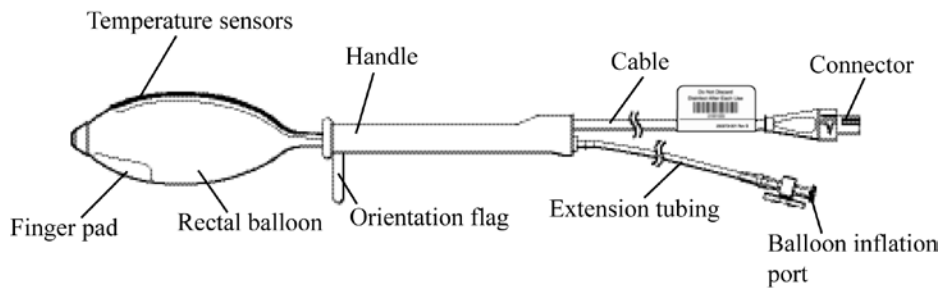

Figure 1-10a: RTU Features

With the single Use RTU, the Orientation Flag allows the clinician to verify that the RTU sensors are facing the anterior wall of the rectum. The flag must be pointed toward the patient’s posterior.

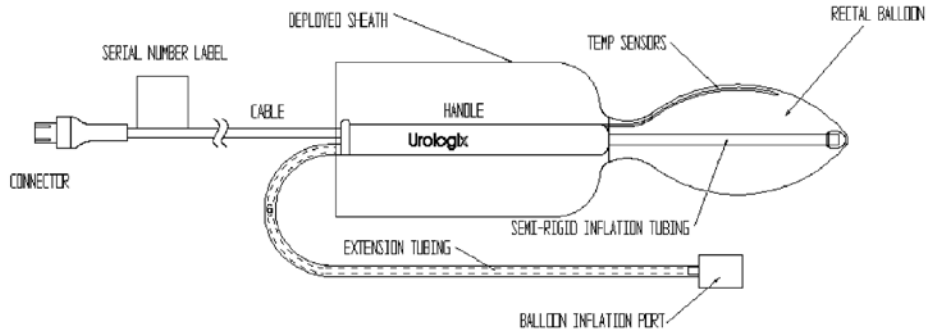

Figure 1-10b: Assembled RTU Plus Features

In the reusable RTU Plus, the proper orientation is achieved by placing the side of the handle labeled “Anterior” face up. As such, when the patient is positioned on his back the handle base would be resting on the table and the Urologix logo would be visible on both sides of the handle. This assures that the temperature sensors of the RTU Plus are pointed towards the patients prostate / anterior.

1.7 Coolant Bag

The single use Coolant Bag includes a bag for chilled water, inlet and outlet tubing, a sensor module, and connectors (figure 1-11). The function of the bag is to provide a reservoir for coolant that is circulated through the MDS during treatment. The Coolant Bag includes these functional components:

Small holes on the top and bottom of the Coolant Bag allow it to be mounted on the chill plate. A hydrophobic vent releases air (but not coolant) from inside the bag.

A sensor module allows coolant temperature and pressure to be monitored by the Control Unit.

The sterile water circulates through the coolant inlet tubing, sensor module and outlet tubing which connects to the MDS. Water continues to circulate through the MDS and returns to the Coolant Bag via the Coolant Bag inlet tubing. The Coolant Bag resides against the chill plate which removes heat from the circulating sterile water.

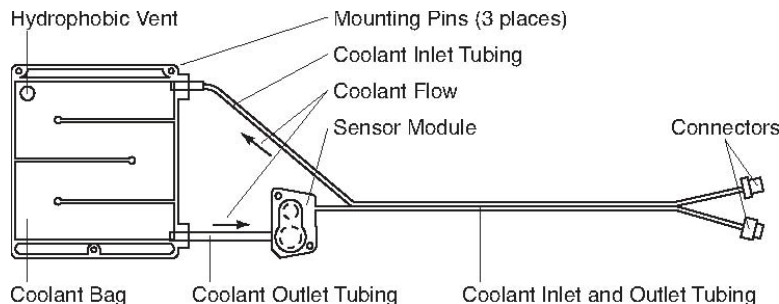

Figure 1-11: Coolant Bag Features



Caution: Use only sterile water in the Coolant Bag. Do not fill the Coolant Bag with saline solution. Saline solution has electrical properties that can interfere with microwave energy from the MDS during treatment.

1.8 Required Equipment

The following equipment is needed to successfully treat patients with the Targis System.

1.8.1. Equipment Provided by Urologix

The following equipment is provided by Urologix:

Quantity	Equipment/Material
1	Targis Control Unit
1	Procedure Kit containing: <ul style="list-style-type: none"> • 1 Microwave Catheter (either Targis, Cooled ThermoCath, or CTC Advance) • 1 Rectal Thermosensing Unit (standard RTU or RTU Plus) • 1 Coolant Bag
1	Patient Comfort Kit (2 knee cushions and a Microwave Catheter Holder)

1.8.2 Equipment Provided by the User

The following equipment is typically provided by the user.

Quantity	Equipment/Material
1	Foley catheter, 16-18 French
1	Straight catheter, 14-16 French
1	Urine drainage bag
As needed	Sterile gloves
As needed	Anesthetic lubricating jelly (e.g. Urojet or lidocaine jelly)
50 cc	Local bladder anesthetic of choice (e.g., 50 cc of 1% or 2% lidocaine without epinephrine)
As needed	Water soluble lubricating gel (e.g., K-Y Jelly)
1	60 cc luer-lock syringe
1	60 cc catheter-tip syringe (e.g. Toomey™ syringe)
2	10 cc luer-lock syringe
200 cc	Sterile water for coolant bag and catheter balloons
1	Ultrasound system
1	Catheter plug
As needed	Permanent marker or tape
As needed	Nonsterile gloves
1	Penile clamp
1	Specimen cup
1	Urinal or graduate
As needed	Ice or ice pack

1.9 Control Unit Installation and Use Environment

Before unpacking the Targis Control Unit, inspect the shipping crate for signs of damage.



Warning: DO NOT USE components that have evidence of a compromised package or damage.



Caution: Do not stack any objects on top of Targis Control Unit, Microwave Catheter, RTU, or Coolant Bag.



Caution: Do not place the Control Unit near any electronic device or other equipment emitting electromagnetic waves. The interference may compromise the operation of the equipment.

Remove the Targis Control Unit from the shipping crate and inspect the device for damage that may have occurred during shipment. Retain the shipping material should the Control Unit need to be returned for service. Visually check:

- Targis Control Unit for obvious damage
- Pump latch and coolant door to see that they are operating correctly
- Patient connection cable, patient connection cable housing, and connectors for kinks, cuts, dirt, contamination, or obvious damage

The recommended environment for use includes:

Providing ventilation space of at least 20 cm clearance around the base of the Control Unit for operation.

Operating the Control Unit on a level surface.

Operating conditions:

An ambient temperature range of +10° C to +30° C

A relative humidity range of 30% to 75%

An atmospheric pressure range of 700 hPa to 1,060 hPa

The equipment must be connected to a fully tested, hospital grade power outlet with adequate grounding.

Power requirements

European version:	220/240 V [+/- 10%] (4.25 A) Single phase 50 or 60 Hz
U.S. version:	110/120 V [+/- 10%] (8.5 A) Single phase 50 or 60 Hz

If required, an equal potential ground cable should be connected to the Control Unit (*figure 1-12*) and the appropriate ground.

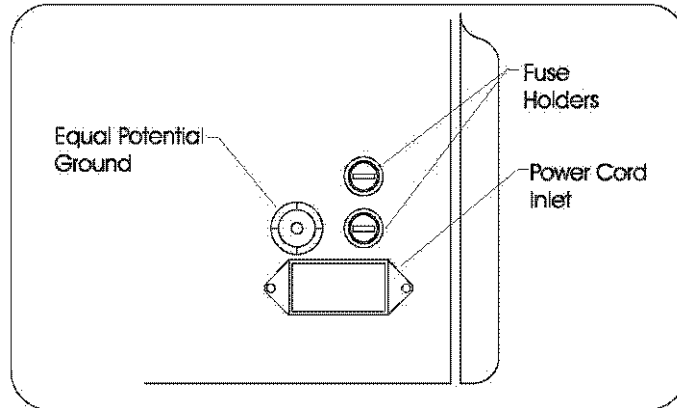

Figure 1-12: Targis Control Unit Rear Cover

1.10 Equipment Cleaning

Follow these instructions to clean the Control Unit exterior:

Clean the exterior surface of the Control Unit using a lint-free cloth dampened with warm water and a 10% solution of mild detergent, or a diluted, non-abrasive, non-staining, standard hospital disinfectant. Use a lint-free cloth dampened with warm water to wipe the surface of the unit.

Do NOT use isopropyl alcohol (IPA) to wipe the exterior Control Unit housing or the display screen. Using cleaning solvents such as IPA could result in damage to the Control Unit.

1.11 Equipment Connections

The Targis Control Unit must not be connected to any device other than the MDS, RTU, or Coolant Bag.

The MDS, RTU, and Coolant Bag must not be connected to any other device or outlet.

1.12 Equipment Testing

Turn on the unit, and verify that the initial screen display has appeared. Do not use the Control Unit if there are any irregular sounds or vibrations present.

Prior to beginning a Cooled ThermoTherapy procedure, verify that all components of the Procedure Kit (MDS, RTU, and Coolant Bag) have arrived in a sealed condition.

1.13 Safety Instructions

 **Warning:** Do not open the housing of the Targis Control Unit. Doing so risks receiving an electric shock.

 **Warning:** This equipment is not intended for use in areas where there is a danger of explosion.



Caution: The Targis Control Unit must be operated by trained and authorized personnel. You should read and understand the instructions in this manual before operating the system.

Do not open the housing of the Targis Control Unit. An electrical shock hazard exists if the housing of the control Unit is opened. Refer all Control Unit servicing to qualified Urologix personnel.

Do not use the Control Unit in the presence of flammable substances.

This manual does not claim to address all of the safety concerns associated with the use of this equipment. The user must establish appropriate safety and health practices prior to use.

Perform the following Control Unit safety checks at least once every 12 months:

Check all cables and connectors for damage

Check equipment for physical damage

Ensure that safety labels are readable

Maintain a written record of these safety checks. Any equipment that does not meet these standards should be serviced.

Safety Precautions

General Safety

The Targis System is a medical device equipped with the ability to emit microwave radiation, therefore the user must ensure the following general safety precautions are observed:

- The Targis System must only be installed and serviced by qualified service personnel.
- The Targis System may not be used for any purpose other than those for which it is designed and approved, and then only in accordance with this manual.
- The Targis System may be used only by authorized and properly trained personnel, and the treating physician must be present throughout the duration of the Cooled ThermoTherapy procedure.
- The Targis Control Unit display must be monitored and controlled during the course of a treatment session to make sure that the urethral and rectal temperatures are within prescribed treatment parameters.
- The Targis Control Unit must never be left unattended when the machine is switched ON.

**The Targis System is exclusively for
use by physicians who have been trained.**

**The treating physician should be present at all
times during treatment.**

2.1 Targis Treatment Setup Introduction

The Cooled ThermoTherapy procedure requires several preparation steps. Some of these steps may be done concurrently.

1. Prepare the patient for treatment.
2. Set up the Control Unit.
3. Enter the patient data.
4. Prepare the Coolant Bag.
5. Insert the Microwave Catheter.
6. Insert the single-use standard RTU, or insert the RTU Plus with reusable handle and single-use balloon.
7. Connect the Microwave Catheter and RTU / RTU Plus to the Control Unit.
8. Access the Treatment Checklist Screen.



Note: Medications, such as anti-inflammatory agents, may be given to the patient at the discretion of the physician based on the patient's physical and mental well-being.

2.2 Prepare the Patient

To prepare the patient for treatment, follow these steps:

1. Ensure the patient has received adequate information about the treatment and post-treatment expectations and has provided informed consent.
2. Perform an enema 1 to 2 hours before treatment or per physician instructions.
3. Administer pre-operative medications at this time, such as local anesthetics, antibiotics, non-steroidal anti-inflammatory agents. It is important that the patient not be over sedated. This may compromise his ability to communicate pain.

2.3 Prepare and Position the Targis Control Unit

1. Position the Targis Control Unit close enough to the patient so that the patient connection cable is able to reach the MDS and RTU / RTU Plus easily. The Control Unit should be placed on a level surface.
2. Lock the front wheels to ensure the Control Unit does not move inadvertently. To lock the wheels, use your foot to press down on the front part of the wheel lock tabs. To unlock the wheels, press on the back part of the wheel lock tabs.
3. Plug the Control Unit electrical cord to a wall outlet. The power supply must have these specifications:

2.4 Power Requirements

Europe version:	220/240 V [+/- 10%] (4.25 A) Single phase 50 or 60 Hz
US version:	110/120 V [+/- 10%] (8.5 A) Single phase 50 or 60 Hz
Connections:	Hospital-grade plug



Warning: Do not move the Control Unit while the electrical cord is connected to a power source.

2.5 Turn on the Targis Control Unit

1. Turn on the Targis Control Unit by pressing the ON / OFF switch (located on the right side of the unit) to the “|” position. The Control Unit then proceeds with its startup routine. Verify that the Startup display Screen (*figure 2-1*) is displayed on the monitor.

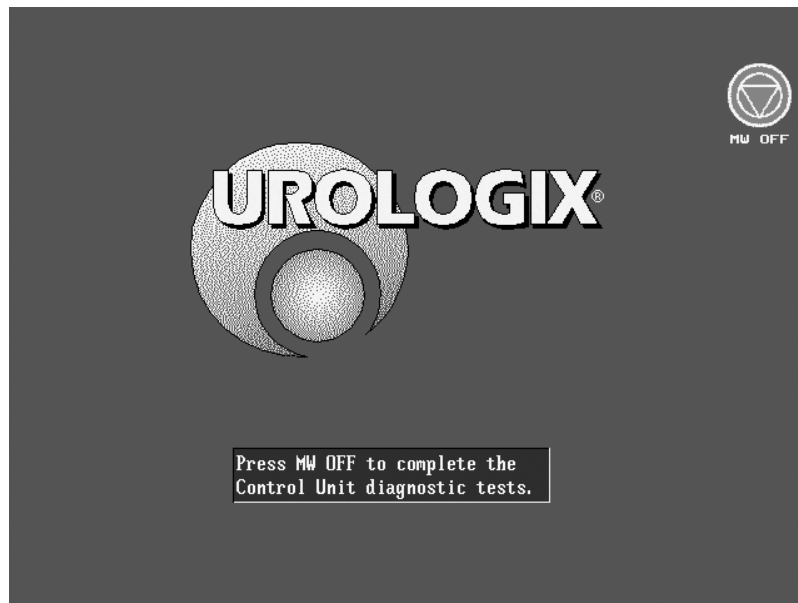

Figure 2-1: Startup Display Screen



Note: Turn ON the Control Unit at least 5 minutes before treatment begins to allow the system to warm up.

2. After the Control Unit has been operating for at least 5 minutes, press the MW OFF soft key to verify its operation and advance to the Main Menu Screen (*figure 2-2*).

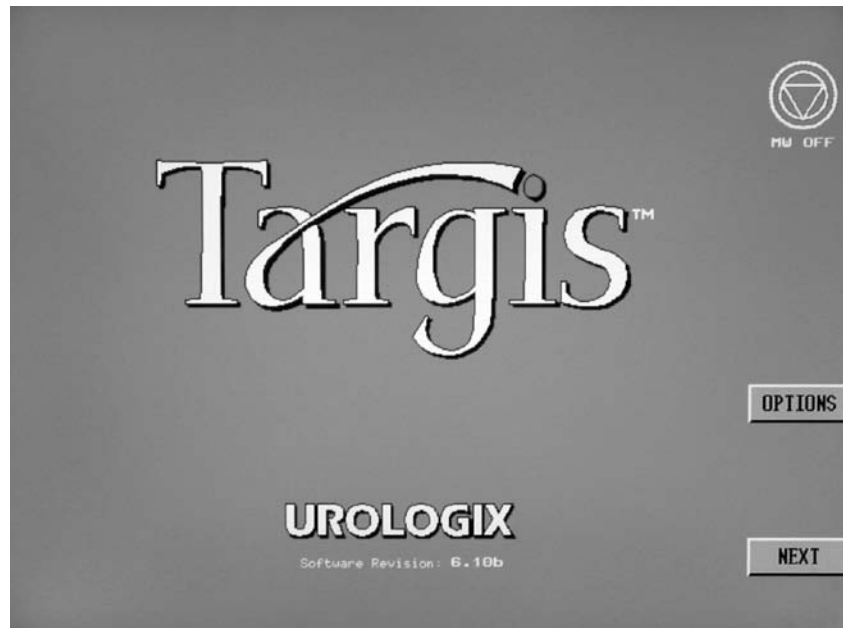

Figure 2-2: Main Menu Screen

2.6 Enter Patient Data

1. Pull the keyboard drawer out on the top front panel of the unit. You will use the keyboard to enter patient data.
2. Press the NEXT soft key (*figure 2-2*) on the monitor to advance to the Patient Data Display Screen (*figure 2-3*).

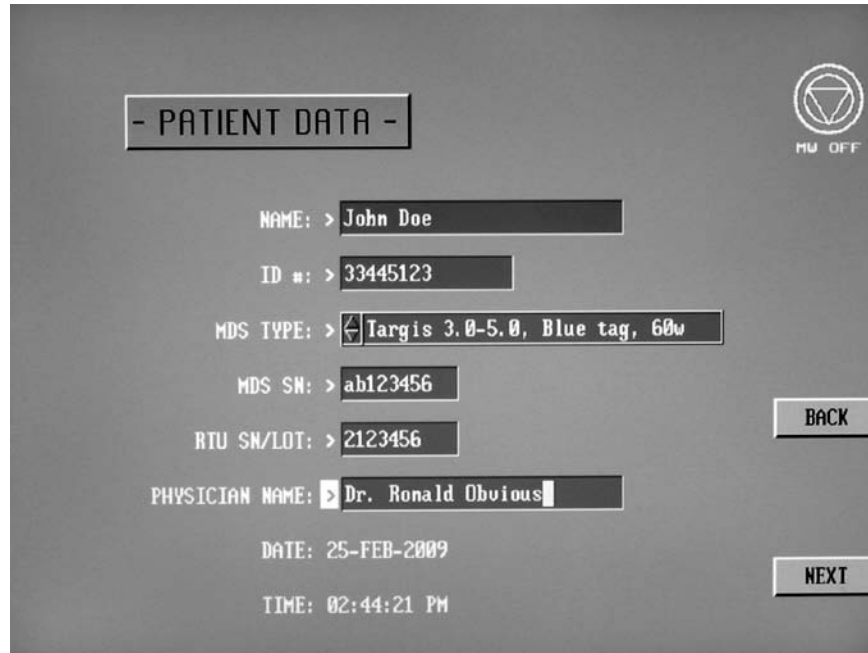
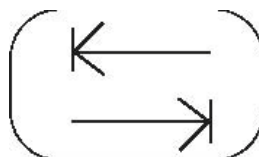

Figure 2-3: Patient Data Display Screen

3. Enter patient data using the keyboard as prompted on this screen, and using the following format guidelines:

- Name: [Enter the patient’s name up to 25 alphabetic characters.]
- ID #: [Enter the patient’s hospital medical record number or clinic ID. You can enter up to 15 alphanumeric characters.]
- MDS Type: [Press up / down arrow to change type.]
- MDS S/N: [Enter the MDS serial number printed on the MDS.]
- RTU SN/Lot: [Enter the Single Use RTU lot number on the packaging label or the RTU Plus Handle serial number located on the device.]
- Physician Name: [Enter the treating physician name.]
- Date: [Displays Control Unit date in the format: dd-mmm-yyyy, date can be changed using the OPTIONS functions on Main Menu Screen (figure 2-2)]
- Time: [Displays Control Unit time in the format: hh:mm:ss, time can be changed using the OPTIONS functions on Main Menu Screen (figure 2-2)]

To move ahead between fields, press the TAB key on the Control Unit keyboard:



To move cursor ahead to the **next** entry field.

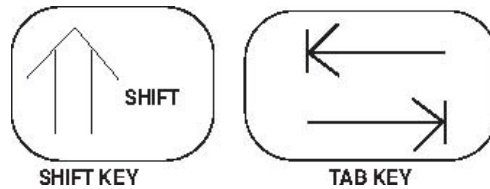

Hold down the SHIFT and press TAB simultaneously to move **back** to the previous field.

If you press the ENTER [↵] key, the data will be entered, but the cursor will not move between fields. Once all of the patient and procedure data are entered (each data field must contain an entry before you can proceed), press the NEXT soft key (*figure 2-3*) on the monitor to advance the Clinical Data Screen (*figure 2-4*).

2.7 Enter Clinical Data

The screenshot shows a screen titled '- CLINICAL DATA -' with a logo in the top right corner. The screen contains several input fields for patient data:

- INSTITUTION: [text input field]
- IPSS: [text input field]
- Qmax: [text input field]
- QOL: [text input field]
- PSA: [text input field]
- URETHRA LENGTH: [text input field]
- PROSTATE VOLUME: [text input field]
- POP: [text input field]
- DUB: [text input field]

There are two soft keys on the right side of the screen: 'BACK' and 'NEXT'.

Figure 2-4: Clinical Data Screen

This screen is used to enter patient clinical data. It is optional and only for the convenience of the user.

- Institution – name of the hospital or clinic.
- IPSS – International Prostate Symptom Score
- Qmax – maximum flow rate
- QOL – Quality Of Life index
- PSA – Prostate Specific Antigen level

Urethra Length – Prostatic Urethra Length, from the bladder neck to the verumontanum, measured in centimeters

Prostate Volume – volume in grams

PVR – post-void residual volume (ml)

DOB – Date of Birth

Press the NEXT soft key (*figure 2-4*) on the monitor to advance to the Treatment Settings Screen

2.8 Prepare the Coolant Bag

Follow these steps to prepare the Coolant Bag:



Instruction Manual: Read the Targis Control Unit User Manual before installing the Coolant Bag.

- 1). Open the package containing the Coolant Bag, and remove the Coolant Bag.
- 2). Fill the Coolant Bag with sterile water (100 cc \pm 5 cc) by injecting the water into the luer fitting of the Coolant Bag with a syringe (*Figure 2-5*).

Once Coolant Bag has been filled, temporarily connect the luer fittings to each other to prevent leakage.



Caution: Use only sterile water in the Coolant Bag. Do not fill the Coolant Bag with saline solution. Saline solution has electrical properties that can interfere with microwave energy from the Microwave Catheter during treatment.



Figure 2-5. Filling the Coolant Bag



Note: To prevent water from leaking out of the Coolant Bag, hold the Coolant Bag connectors above the Coolant Bag or, loosely, temporarily connect them together.

3). Open the coolant door on the front of the Control Unit by pulling the top of the door forward. Position the Coolant Bag over the chill plate by aligning the top two mounting holes of the Coolant Bag with the top two mounting pins on the chill plate. Gently position the Coolant Bag onto the pins (*Figure 2-6*).



Figure 2-6. Positioning the Coolant Bag onto the Top Mounting Pins

4). Complete the process of installing the Coolant Bag by positioning the bottom mounting hole over the lower mounting pin below the chill plate (*Figure 2-7*).

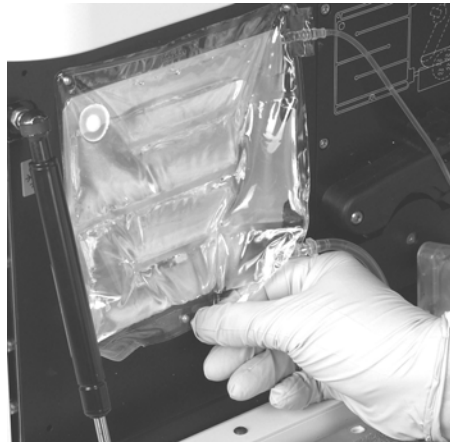



Figure 2-7. Positioning the Coolant Bag onto the Lower Mounting Pin



Caution: Do not allow the Coolant Bag connectors to fall on the floor during installation.

5). Route the Coolant Bag inlet tubing through the pump mechanism by pulling out the locking lever located on the upper pump tubing clamp and lifting the tubing clamp up. Lay the pump tubing of the Coolant Bag across the center of the pump mechanism (*Figure 2-8*).

 **Note:** To prevent damage from occurring to the Coolant Bag, never leave the coolant door in the open position.

 **Note:** Ensure inlet tubing is properly seated in the notch of the lower pump housing. Ensure that the coolant tubing is not twisted.

6). When the Coolant Bag is mounted correctly on the chill plate, the Coolant Bag inlet tubing and sensor module are aligned with the pump mechanism (*Figure 2-8*).

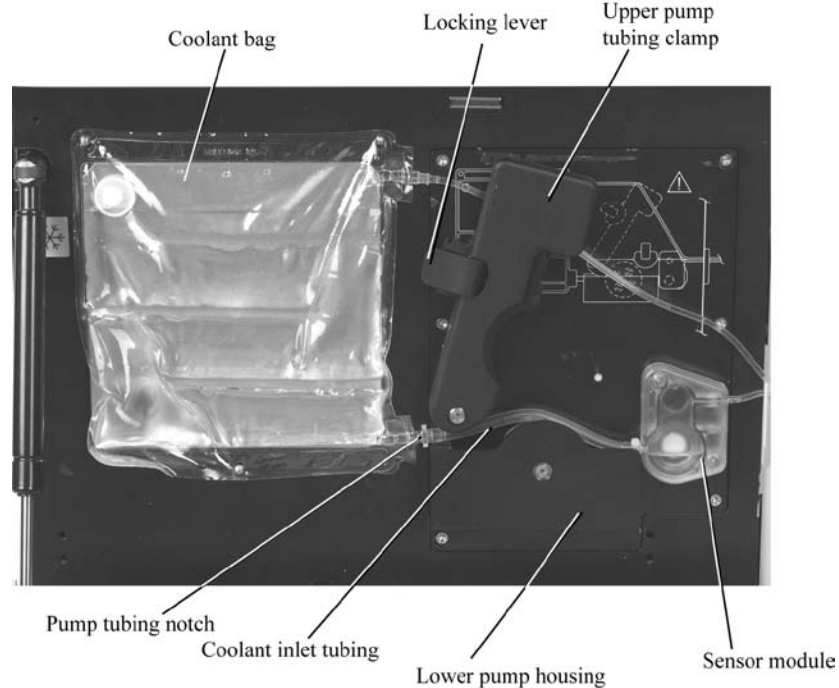

Figure 2-8. Coolant System with Pump Mechanism Open

7). Place the Coolant Bag pump tubing (inlet tubing) of the Coolant Bag under the upper pump tubing clamp and across the rotor of the pump mechanism (*Figure 2-8*).

8). Align the Coolant Bag sensor module with the locating pins to the right of the pump mechanism (*Figure 2-9*).

9). Push down the pump tubing clamp until it snaps into position (*figure 2-10*).

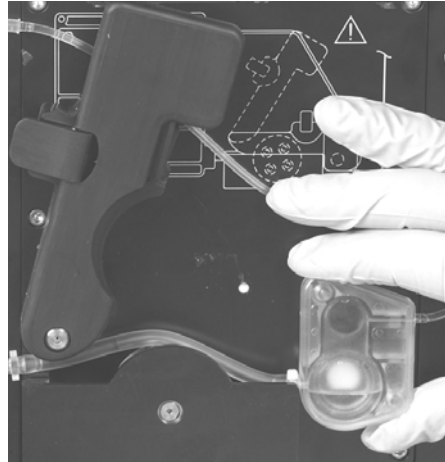

Figure 2-9. Positioning the Sensor Module

10). Ensure the coolant inlet tubing is properly seated into the notch of the lower pump housing clamp.

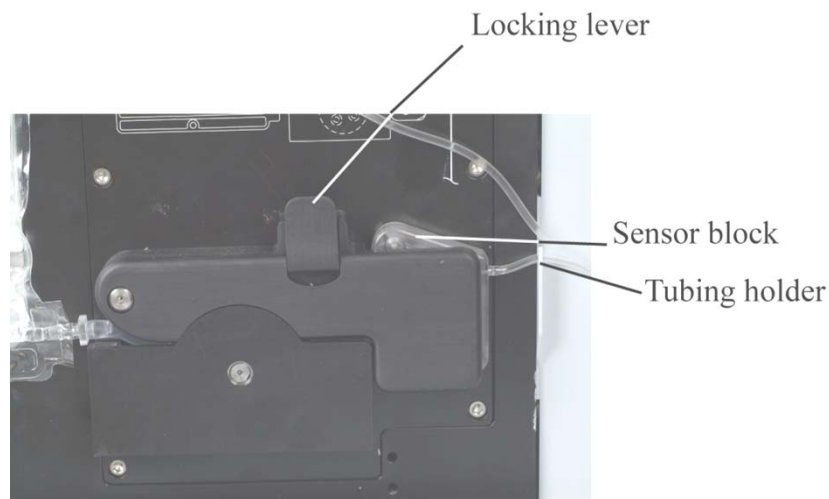

Figure 2-10. Coolant System with Pump Closed

11). Insert the coolant inlet and outlet tubing into the tubing holder next to the ON/OFF switch. This will prevent the tubing from being pinched by the coolant door.

12). Close the coolant door completely.

Note: The coolant delivered to the Microwave Catheter may not be at the desired temperature if the coolant door is not completely closed. In addition, a closed coolant door prevents damage to the coolant bag.

2.9 Insert the Microwave Catheter

Select the appropriate catheter model as per table:

Microwave Catheter	Prostatic Urethral Length	Catheter Color Scheme	Serial Number Tag Color	Serial Number Prefix
CTC Advance - Short	2.5 to 3.5 cm	Blue Handle Black Accents	Black	TH
CTC Advance or Cooled ThermoCath - Standard	3.0 to 5.0 cm	Blue* Handle White Accents	White	TC
CTC Advance or Cooled ThermoCath - Long	≥ 4.5 cm	Blue* Handle Grey Accents	Grey	TF
Targis - Short	2.5 to 3.5 cm	White Catheter Green Handle	Green	AB
Targis - Standard	3.0 to 5.0 cm	White Catheter White Handle	Blue	AB

*NOTE: A dark blue handle is Cooled ThermoCath, the light blue is the CTC Advance.



Warning: Selection and use of the appropriate catheter model is required to assure patient safety. Verify that the correct catheter has been inserted in the patient.

1. Drain patient's bladder.
2. Inject anesthetic mixture of choice into bladder.
3. Inject anesthetic lubricant mixture of choice into the urethra and clamp penis to contain within the urethra for 20-30 minutes.
4. Open the package containing the Microwave Catheter.
5. Test the locating balloon by filling it with 10 cc of sterile water, examining it for leaks and then draining.
6. Lubricate the Microwave Catheter tip and shaft with a water-based lubricant or local anesthetic.

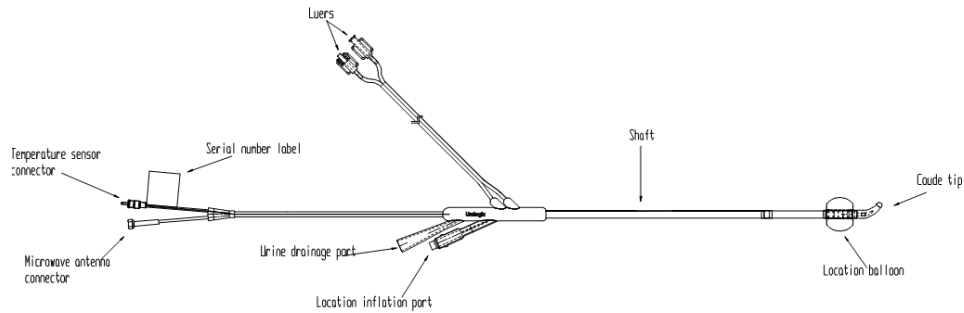

Figure 2-11a: Targis MDS

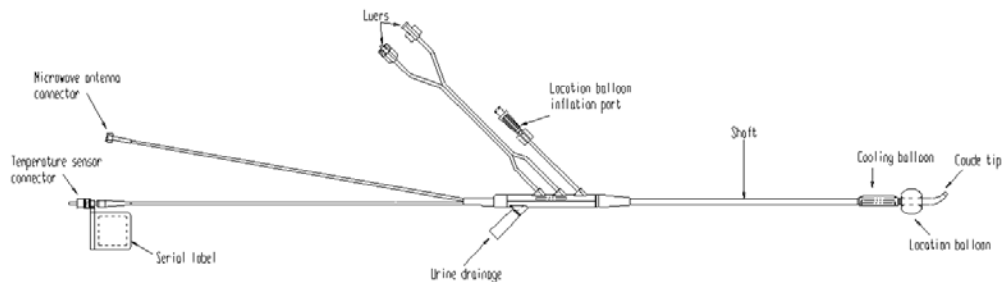

Figure 2-11b: CTC Advance MDS

7). Insert the MDS into the patient's urethra until the location balloon is completely in the bladder. Align the MDS so that the urine drainage port is pointed toward the patient's posterior and the coolant tubing is in an anterior orientation.



Warning: Do not overinflate the Microwave Catheter balloon. Over-inflation may result in balloon malfunction and possible improper positioning of the microwave antenna. Under-inflation can cause the antenna to be misplaced in the prostate, affecting the external sphincter.



Caution: The microwave antenna on the distal end of the Microwave Catheter may break if you bend it. Do not grab the Microwave Catheter or squeeze it in the area of the antenna or the shaft. The optical fiber located in the flexible shaft may be broken if it is clamped.

8). Inflate the location balloon with 10 cc of sterile water. Pull back on the MDS until you feel mild resistance.

9). Flush the urine drainage lumen with 4 cc of sterile water. Attach a urine drainage bag or catheter plug.

10). Position the MDS properly by pulling on it until the balloon is seated in the bladder neck, locating the microwave antenna within the preprostatic urethra (*Figure 2-12*). **Verify MDS position with the ultrasound probe.**



Warning: Proper position of the location balloon is essential to patient safety.

11). If the MDS position is not acceptable, it may have to be rotated or reinserted. Push the MDS through the urethra until the MDS balloon is completely in the bladder. Rotate the MDS, and then pull back until you feel mild resistance (*Figure 2-12*). **Verify the position of the MDS with ultrasound.**

12). If using a Cooled Thermocath MDS or CTC Advance MDS, flush the cooling system with 3-5 cc of sterile water and connect luers together.

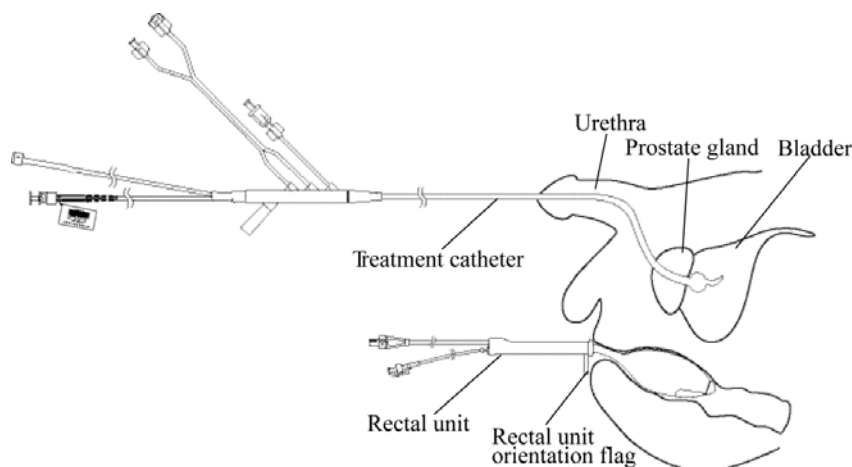

Figure 2-12. Inserted MDS and Single Use RTU



Warning: Insulate the antenna cable away from the patient's legs. The cable can become hot to the touch during extended treatment at high power levels.



Warning: Avoid excessive force when pulling back on the Microwave Catheter to seat the balloon at the bladder neck. Excessive force could injure the patient or damage the catheter.

2.10 Preparing and Inserting the Single-Use Standard RTU

Note: The Single Use RTU pictured below.

- 1). Verify the patient has received an enema.
- 2.) Open and remove the RTU from the sealed packaging.

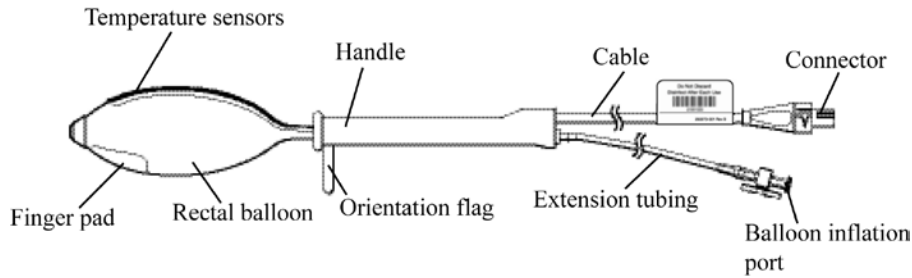

Figure 2-13. Standard RTU

- 3). Deflate the RTU balloon completely by attaching a syringe to the inflation port and withdrawing air. The RTU should be deflated with the temperature sensors centered.
- 4). Lubricate the RTU balloon and insert into the rectum with the index finger aligned under the temperature sensors which should be oriented toward the prostate. The orientation flag must be pointing toward the patient's posterior.



Warning: The rectal unit must be positioned properly to ensure correct temperature sensing.

- 5). Inflate the rectal balloon by injecting 120 cc of air into the inflation port located on the proximal end of the RTU. Adjust air volume to a minimum of 80 cc for patient comfort. Close RTU valve.
- 6). Verify proper positioning of the RTU by observing that the orientation flag located on the RTU. The orientation flag should be facing away from the prostate, toward the patient's posterior.



Warning: A minimum of 80 cc of air in the standard RTU rectal balloon is required to maintain contact between the temperature sensors and the rectal wall.



WARNING: THIS VISUAL REFERENCE SHOULD BE MADE EVERY 5 TO 10 MINUTES THROUGHOUT THE TREATMENT TO VERIFY THE PROPER POSITION OF THE RECTAL THERMOSENSING UNIT. FAILURE TO PROPERLY ORIENT THE RTU DURING TREATMENT CAN RESULT IN PATIENT INJURY (E.G. FISTULA OR SCROTAL BURN)

2.11 Preparing and Inserting the reusable RTU Plus Handle

Follow these steps to prepare the reusable RTU:

- 1). Verify the patient has received an enema.
- 2). Open the package for the RTU Plus Reusable Handle, or obtain a disinfected RTU Plus Handle from a previous treatment (*Figure 2-14*). The RTU Plus Handle with the temperature sensors should not be used in more than 30 treatments.

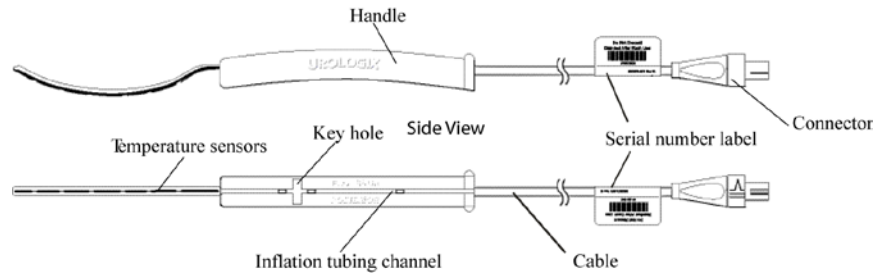

Figure 2-14. RTU Plus Reusable Handle

- 3). Open the package for a RTU Plus Disposable Balloon.
- 4). Inflate balloon to approximately 70 cc to verify no leaks are present. Remove air before proceeding to step 5.

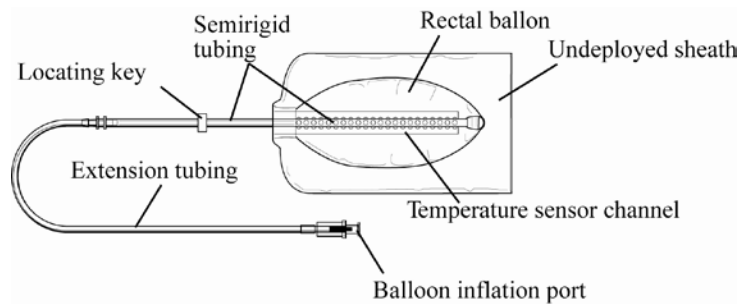

Figure 2-15. RTU Plus Disposable Balloon

- 5). Insert the temperature sensor strip, with the sensors oriented so that they will be toward the outside of the balloon, into the temperature sensor channel entrance of the Disposable Balloon, as shown in (*figure 2-16*), being careful not to bend the temperature strip significantly. Ensure that the temperature sensor strip is extended to the distal end of the temperature sensor channel and the temperature sensor channel is aligned with the top of the handle.



Figure 2-16. Inserting the Temperature Sensor Strip

6). Seat the balloon inflation tubing in the inflation tubing channel in the base of the RTU Plus handle. The locating key should snap into place within the handle key hole; if not, reorient/reassemble the device. The proper positioning of the temperature sensor strip in the disposable balloon is assured by the locating key/handle interaction (*Figure 2-17*).

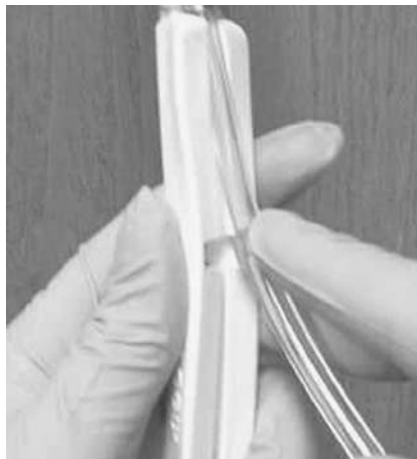

Figure 2-17. Proper Positioning of the Temperature Sensor Strip

- 7). Once the handle and balloon are integrated, the protective sheath must be slid down from the balloon and pulled over the handle.
- 8). Lubricate the balloon area with a water-based lubricant (e.g. K-Y Jelly).
- 9). If necessary, deflate the RTU Plus balloon completely by attaching a syringe to the inflation port and withdrawing air.
- 10). Slowly insert the balloon into the rectum using the semi-rigid inflation tubing to guide placement. This can be done with the guiding hand initially over the distal balloon area.

Advance the RTU Plus slowly. The guiding hand can be moved more and more proximally as the RTU Plus is properly inserted into the rectum. **The rectal temperature sensors must be oriented toward the prostate.**



Warning: The rectal unit must be positioned properly to ensure correct temperature sensing.

11). The RTU Plus orientation should be verified by inserting a finger and assuring proper alignment. The side of the RTU Plus labeled “Anterior” will be facing up when properly positioned.



WARNING: THIS VISUAL REFERENCE SHOULD BE MADE EVERY 5 TO 10 MINUTES THROUGHOUT THE TREATMENT TO VERIFY THE PROPER POSITION OF THE RECTAL THERMOSENSING UNIT. FAILURE TO PROPERLY ORIENT THE RTU DURING TREATMENT CAN RESULT IN PATIENT INJURY (E.G. FISTULA OR SCROTAL BURN)



Warning: A minimum of 70 cc of air in the RTU Plus rectal balloon is required to maintain contact between the temperature sensors and the rectal wall.

12). Inflate the rectal balloon by injecting 90 cc of air into the inflation port, located on the proximal end of the RTU. Adjust the air volume to a minimum of 70 cc for patient comfort.

13). The physician must confirm the proper positioning of the RTU Plus prior to proceeding.



Note: When a reusable RTU Plus is being used, the Treatment checklist screen will display the number of times the handle has been used and the number of remaining uses. The reusable RTU Plus should not be used in excess of 30 times.

2.12 Connect the MDS and RTU to the Control Unit



Note: To relieve pressure on the RTU and increase patient comfort, position patient so that he is reclining on his back, with head and shoulders elevated no higher than a 20° angle.



Warning: Excessive elevation of the patient’s torso may put additional pressure on the rectal unit, resulting in increased patient discomfort and higher rectal temperatures.

1). If necessary, reposition the patient on his back with his head and shoulders at less than a 20° angle.

- 2). Gently pull on the MDS to reseat the location balloon at the bladder neck in case it moved during RTU insertion. If ultrasound was not used to verify Microwave Catheter position prior to rectal unit insertion, use ultrasound at this point to verify proper Microwave Catheter position.
- 3). Secure the Microwave Catheter into the Microwave Catheter holder, with the cooling lines in the anterior position.
- 4). Mark position on MDS at penis meatus with marker.



Caution: THIS VISUAL REFERENCE SHOULD BE CHECKED EVERY 5 TO 10 MINUTES THROUGHOUT THE TREATMENT TO VERIFY THE PROPER POSITION OF THE MICROWAVE CATHETER AND THE RECTAL THERMOSENSING UNIT.

- 5). Secure the Microwave Catheter fiber optic and microwave connectors to the patient connection cable housing (*figure 2-18*).
- 6). Connect the coolant tubing connectors of the MDS to the coolant bag connectors.
- 7). Attach a urine drainage bag to the urine drainage port of the MDS.
- 8). Insulate the antenna cable away from the patient's legs. The cable can become hot to the touch during extended treatment at high power levels.

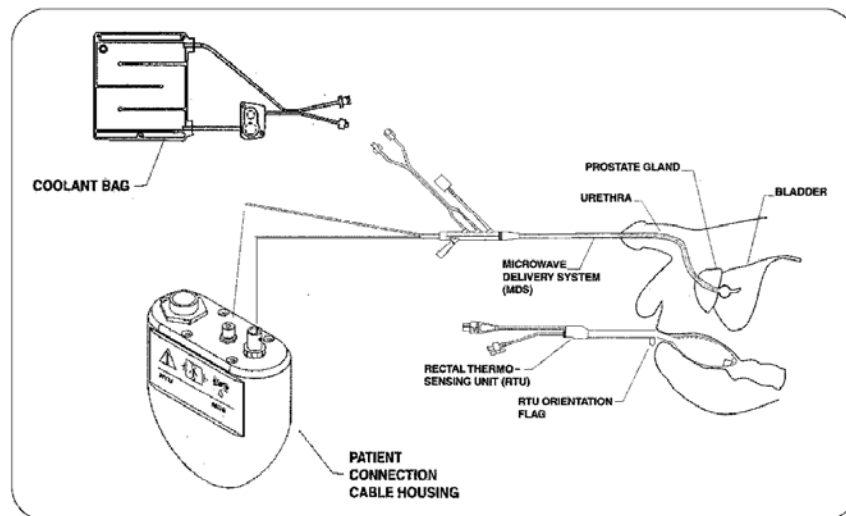

Figure 2-18: Connected MDS and RTU: Note The single use RTU is pictured above.



Note: Failure to fill the urine drainage lumen may cause system calibration errors.



Warning: Do not touch the antenna cable or the catheter handle while microwave power is ON. Touching the cable or the handle while microwave power is ON can cause burns as the CTC Advance antenna cable may reach up to 69.7°C and the Targis antenna cable may reach 82.1°C at room temperature. To prevent burns during treatment, isolate the antenna cable and the catheter handle away from the patient's legs.

9). Connect the rectal unit connector to the patient connection cable housing (*Figure 2-19*).

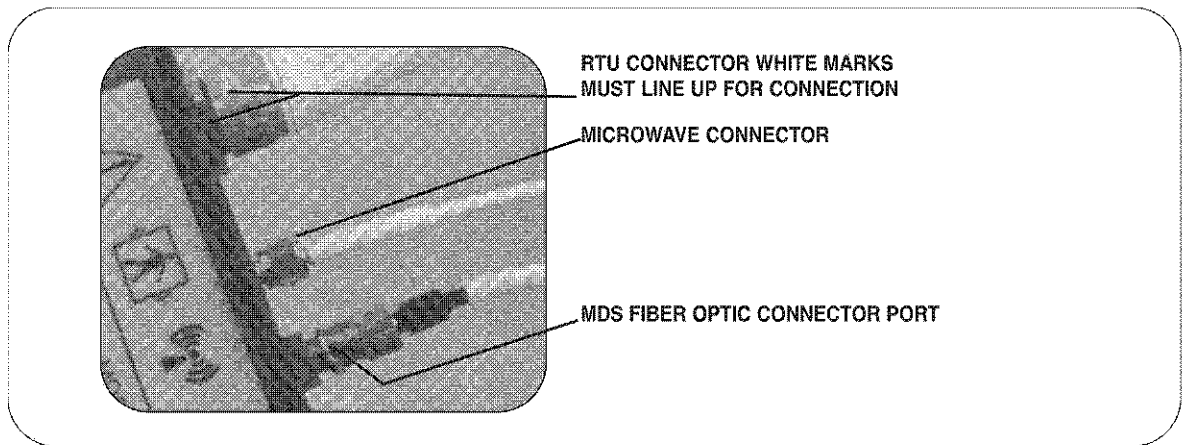

Figure 2-19: Patient Connection Cable

3.1 Treatment Settings Screen

This screen displays the initial settings for treatment. The settings can be changed later during treatment if desired.

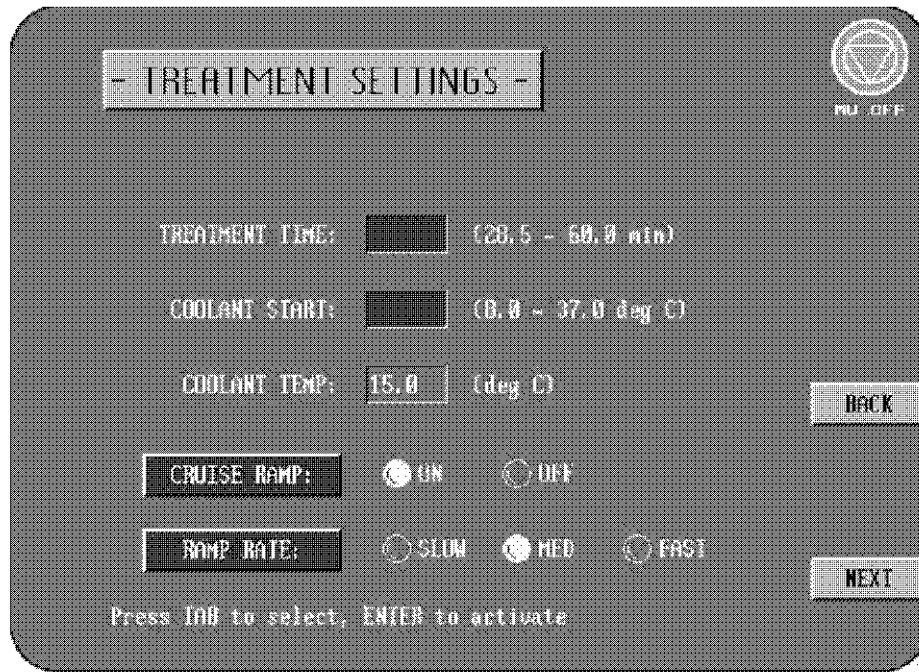

Figure 3-1: Treatment Settings Screen

3.1.1 Treatment Time

The initial length of time that the user is planning for treatment. This value can be set from 28.5 minutes to 60.0 minutes in 0.5 minute increments for the Targis MDS or 28.5 minutes for the Cooled Thermocath MDS or CTC Advance MDS.

This value can be changed during treatment, and only determines when Cruise will automatically end. It has no effect on the Manual Control panel.

3.1.2 Coolant Start

This is the initial starting value of the Coolant Ramp. Coolant will ramp from this value to the target value.

Default Start and Target values are defined in table below	Default Start	Default Target
Targis Microwave Catheter	15°C	8°C
CTC Advance and Cooled ThermoCath Microwave Catheters	20°C	15°C

3.1.3 Coolant Temp

This is the current measured value of the surface of the chill plate. Wait until this value has reached the Coolant Start temperature above, before beginning calibration.

3.1.4 Cruise Ramp

ON, OFF

This will determine if the system will begin to ramp MW Power using Cruise II, or begin in manual mode.

3.1.5 Ramp Rate

SLOW, MED, FAST

The Ramp Rate controls how rapidly the MDS and Coolant temperatures are changed from their initial values to their final target set points. The MDS temperature ramp is active in Cruise mode only. The Coolant ramp is active in Manual mode as well.

The initial rate is selected here and can be adjusted throughout treatment. (In treatment, the user can also select HOLD, which will maintain MDS and Coolant at their present value.)

3.1.6 Navigating the Menu

To move ahead between fields, press the TAB key on the Control Unit Keyboard:

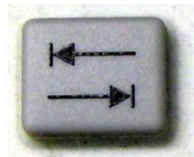

TAB KEY

To move the cursor ahead to the **next** data field.



SHIFT KEY

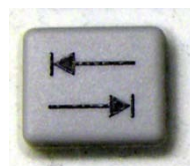

TAB KEY

Hold down the SHIFT key and press the TAB key simultaneously to move back to the previous field.

Press the NEXT soft key and display the Treatment Checklist Screen (*figure 3-2*).

3.2 Begin Calibration and Self-Test Cycle

Treatment Checklist Screen

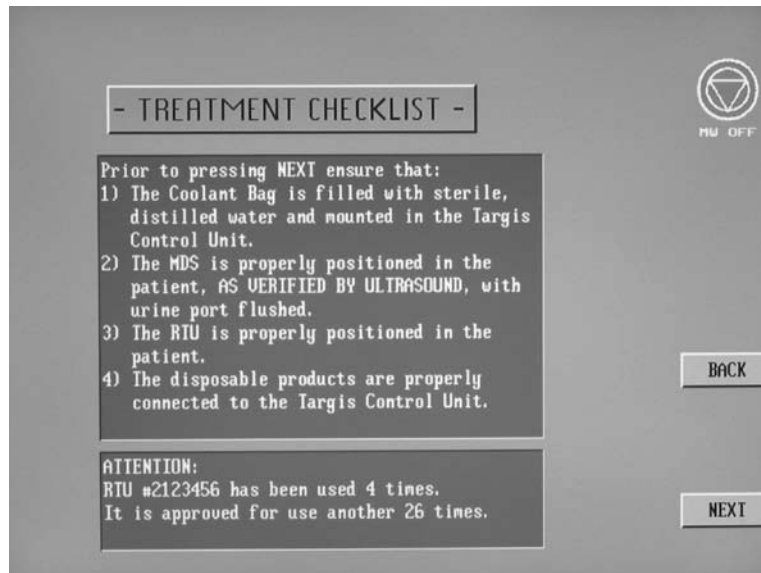

Figure 3-2: Treatment Checklist Screen

Please note that when a reusable RTU is being used, the Treatment Checklist screen will display the number of times it has been used, and the number of remaining uses. The reusable RTU Plus should not be used in excess of thirty (30) times. Figure 3-2 displays the Treatment Checklist screen when used with a reusable RTU.

The Treatment Checklist screen contains a list of items that must be verified prior to pressing the NEXT soft key.

1. Review the Treatment Checklist Screen to ensure that all steps have been taken (*figure 3-2*). If you need to change any patient or product data press the BACK soft key on the Treatment Checklist Screen to return to the previous screen.
2. Press the NEXT soft key on the Treatment Checklist Screen to begin calibration.

As the calibration sequence proceeds, the indicator will change to blue. Progress through each calibration step is shown by the vertical bar (*figure 3-3*), and by the word “complete” appearing on the screen after each step. The calibration process requires up to 7 minutes to complete.

3.3 Calibration Progress Screen

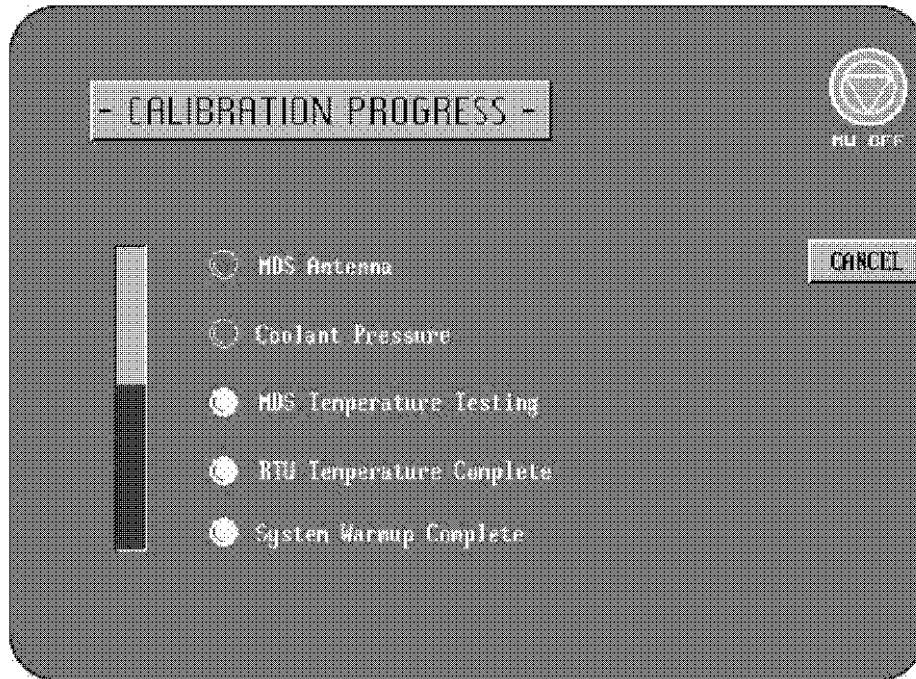

Figure 3-3: Calibration Process Screen

The Calibration Progress screen displays the completion status of each item listed. After a successful calibration, the Treatment Screen will be displayed.

To cancel calibration, press the CANCEL soft key. The Calibration Halted Screen will be displayed.

If the Control Unit does not calibrate, the Calibration Halted Screen will be displayed. Use the error message displayed, and refer to Section 5, Troubleshooting Guide, to resolve the problem.



Warning: If a calibration error message appears, see Section 5, Troubleshooting Guide in this manual for more information.

3.4 Treatment Procedure

After completing Calibration, the Targis system will enter one of the two treatment modes, depending upon the user selection on the “Treatment Settings” screen. These modes are: Cruise Control, or Manual Control.

Safety Checks During Treatment Important
<p>It is critical that throughout the patient’s treatment the treating physician verify the correct position of the Microwave Catheter and the RTU. Patient safety is at risk if the following simple and straight forward procedures are not correctly observed.</p> <ol style="list-style-type: none"> 1. Throughout the duration of the treatment, verify that the position mark on the catheter remains at a fixed distance from the penile meatus. 2. It is strongly recommended that at least every 5-10 minutes of the treatment, the correct position of the location balloon in the bladder be checked by transabdominal ultrasound. Document the action by placing the ultrasound in the permanent patient record. 3. Check the correct positioning of the rectal unit at least every 5 to 10 minutes to ensure the rectal unit has not moved. 4. Always immediately check Microwave Catheter and rectal unit placement if the patient complains of any abnormal or sudden increase in pain. Pause the treatment if the patient reports serious pain. 5. Observe the treatment parameters for sudden changes in readings, especially decreases in temperatures that might indicate a sensor has moved from its previous position.

3.4.1 Treatment Screen Description

The Treatment Screen has several panels used to display temperatures, graphing trends, and for selecting and modifying controls.

 Note: The user can switch between Cruise and Manual modes at any time during treatment.

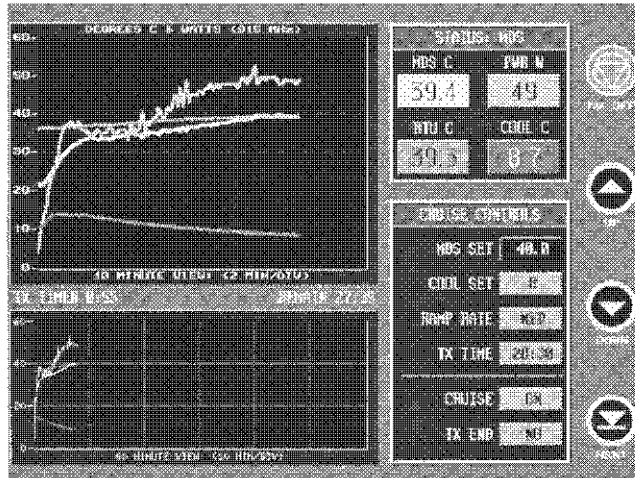
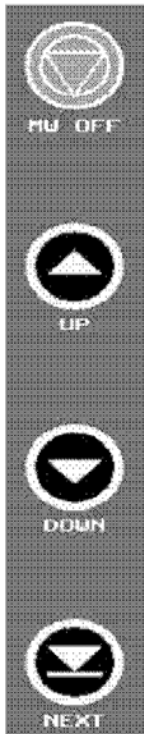

Figure 3-4: Treatment Screen

3.4.1.1 Soft Key Icons

These are the round button images aligned vertically along the right side of the screen. They are positioned adjacent to the rubber “Soft Key” pushbuttons used to control the treatment. Each icon has a text descriptor directly below it to clarify the function of the soft key.

The 4 soft key icons are as follows (figure 3-5):



MW OFF – This is the top soft key, and will disable MW Power immediately whenever it is pressed. This generates an error message, therefore it is preferred that other controls are used for managing patient comfort.

UP/ON/YES – This is the second soft key from the top. It is used to modify the current selected control value. Its function changes depending on the highlighted parameter.

DOWN/OFF/NO – This is the third soft key from the top. It is also used to modify the current selected control value. Its function changes depending on the highlighted parameter.

NEXT – this is the bottom soft key and is used to navigate the highlighted options. It can be pressed at any time without changing any treatment parameters.

Figure 3-5: Soft Icon Keys

3.4.1.2 Status Panel

The Status Panel displays the current values of important treatment parameters.

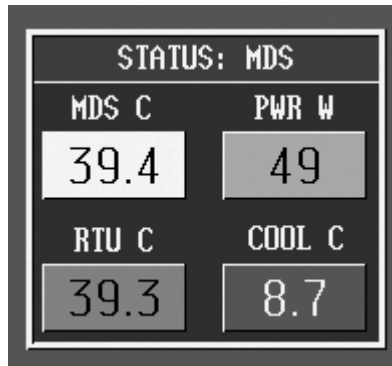

Figure 3-6: Status Panel

These are:

- PWR W
This displays the current MW Power output in watts, measured at the Patient Cable.
- MDS C
This displays the current MDS sensor temperature in degrees C.
- RTU C
This displays the current RTU sensor temperature in degrees C.
- COOL C
This displays the current Coolant sensor temperature in degrees C, as measured by the Coolant Bag sensor block. If the coolant pump is turned off, this reading will gradually approach room temperature.

3.4.1.3 Control Panels

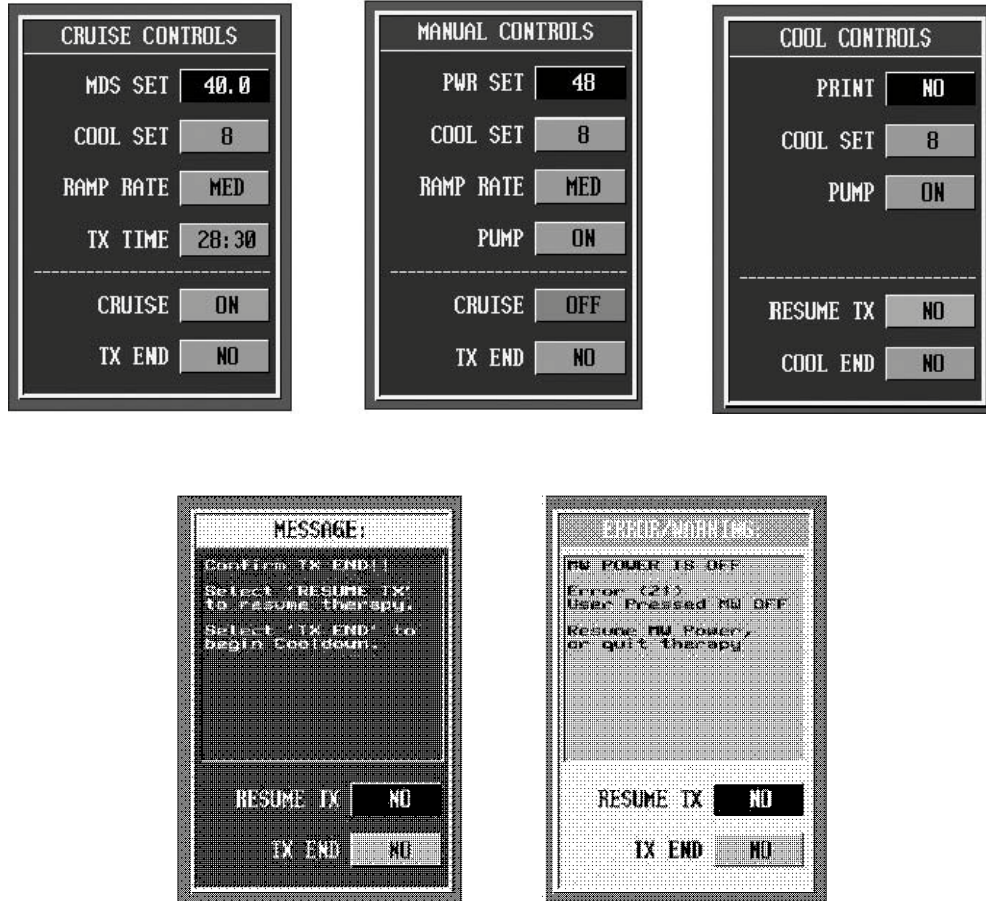

Figure 3-7: Control Panels

The Control Panel displays the current value of treatment parameters and allows the user to modify them.

The Control Panel contains a list of treatment parameters on the right and text description on the left, with the exception of the Message and Error/Warning Control Panels.

Control Panel types: Cruise Controls, Manual Controls, Cool Controls, Message, and Error/Warning.

3.4.1.4 10 Minute Graph

This is a scrolling strip chart displaying MDS temperature, RTU temperature, Coolant temperature, and MW Power as a function of time. The colors of each trace correspond to the color of the item in the Status Panel.

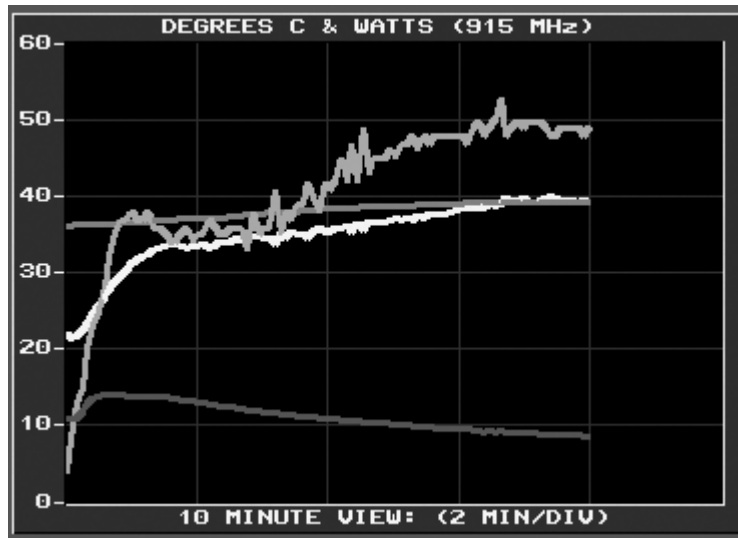

Figure 3-8: 10 minute view

3.4.1.5 60 Minute Graph

This is a scrolling strip chart displaying MDS temperature, RTU temperature, Coolant temperature, and MW Power as a function of time. The colors of each trace correspond to the color of the item in the Status Panel.

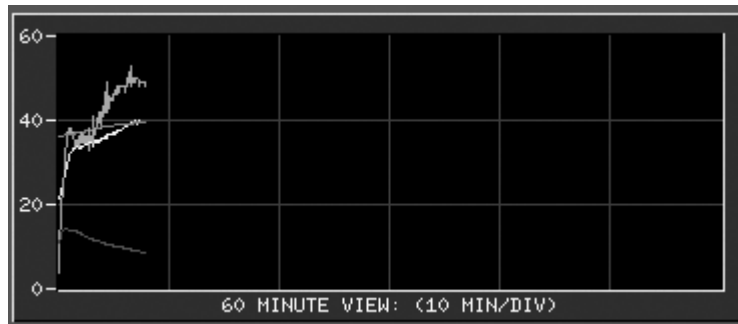

Figure 3-9: 60 minute view

3.4.1.6 Treatment Timers

Below the 10 minute graph are two timers. The timer on the left is always the Treatment Timer, labeled “TX TIMER”. The timer to the right will be one of the following: “REMAIN”, “INTERVAL”, or “COOLDOWN”, depending upon the current active control panel.



Figure 3-10: Treatment Timers

TX TIMER

This records the actual Treatment Time in minutes and seconds, as defined by the following algorithm:

Targis® Short & Standard	CTC Advance® Short	CTC Advance® Cooled ThermoCath® Standard & Long
<ul style="list-style-type: none"> • Urethra ≥ 35 °C, with (Urethra - Coolant) difference ≥ 23 °C • OR: MW Power ≥ 50 W • OR: RTU ≥ 41 °C 	<ul style="list-style-type: none"> • Urethra ≥ 35 °C, with (Urethra - Coolant) difference ≥ 20 °C • OR: MW Power ≥ 50 W • OR: RTU ≥ 41 °C 	<ul style="list-style-type: none"> • Urethra ≥ 35 °C, with (Urethra - Coolant) difference ≥ 20 °C • OR: MW Power ≥ 65 W • OR: RTU ≥ 41 °C

REMAIN

When the Cruise Panel is active, this timer will be displayed. It indicates the Treatment Time remaining, calculated by subtracting the current value of the “TX TIMER” from the value of the TX TIME input by the user. It can be used to tell at a glance when the Cruise will automatically discontinue and enter the Cooldown mode.

INTERVAL

When the Manual Panel is active, this timer will be displayed. It indicates the amount of time elapsed since the user last adjusted MW Power. It can be used to assist the user in timing a manual protocol.

COOLDOWN

When the Cool Panel is active, this timer will be displayed. It indicates the amount of time spent since the MW Power was turned off, and only counts time spent with the coolant pump running.

3.4.2 Control Panel Operation

Each Control Panel displays a list of the current control item settings.

These settings can be adjusted by pressing the [NEXT] soft key until the item to be changed is selected (the background of the control is black).

Once an item has been selected, it can be adjusted by pressing either of the two middle soft keys. These middle soft keys are labeled to correspond to the item selected. For example, they will change from ON/OFF to UP/DOWN to YES/NO.

3.4.2.1 Control Panel: CRUISE CONTROLS

This panel is active when Cruise is engaged.

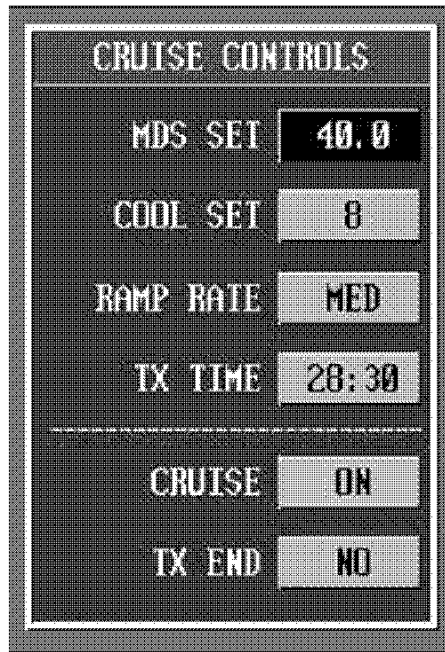

Figure 3-11: Cruise Control Screen

MDS SET – the target MDS temperature set point for the Cruise ramp.

COOL SET – the target Coolant temperature set point for the Cruise ramp.

RAMP RATE – the rate at which Cruise will approach MDS SET and COOL SET.

TX TIME – the time when Cruise will automatically stop MW Power, and switch to the Cool Controls panel.

CRUISE – If the user presses the OFF soft key, the MANUAL CONTROLS panel will be displayed, using the current values for MW Power.

3.4.2.2 Control Panel: MANUAL CONTROLS

This is the control panel displayed when operating in Manual Control.

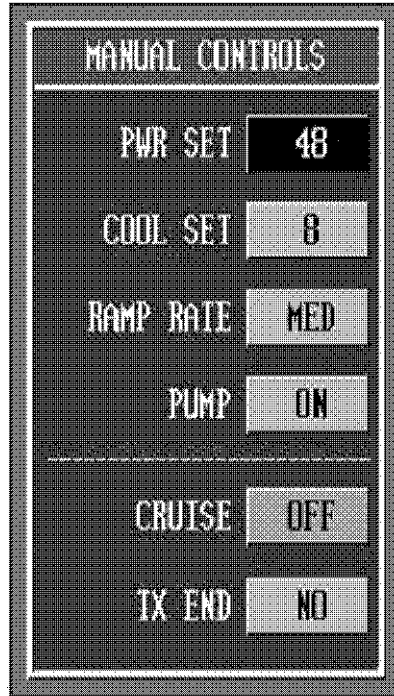

Figure 3-12: Manual Control Screen

PWR SET – the current value of MW Power.

COOL SET – the target Coolant temperature set point.

RAMP RATE – the rate at which Coolant temperature will approach COOL SET.

PUMP – If the user presses the OFF soft key, a message will appear to confirm turning the pump off. When confirmed, the pump will turn off. If MW Power was ON, it will be automatically turned OFF also.

CRUISE – If the user presses the ON soft key, the CRUISE CONTROLS panel will be displayed, using the current value of MDS temperature as the new MDS set point.

TX END – If the user presses the YES soft key, the system will display a confirmation message. If confirmed, the system will stop MW Power and display the Cool Control panel.



Note: The MW Power must be at least 10 watts and MDS must be $\geq 25^{\circ}\text{C}$ before Cruise is allowed to engage.

Note: When Cruise is turned on, the software will ensure that the TX TIME is increased to have at least 2 minutes of treatment remaining. The current MDS temperature will become the set points.

3.4.2.3 Control Panel: COOL CONTROLS

This is the control panel displayed during the Cooldown after treatment.

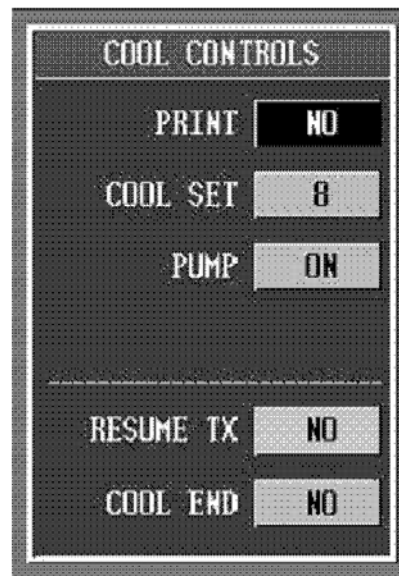

Figure 3-13: Cool Control Panel

Note: Make sure that the Cooldown timer has reached 5 minutes prior to exiting treatment.

Note: The keyboard must be accessed, and the space bar pressed, in order to completely exit a treatment.

- PRINT – Press YES to print a listing of the treatment.
- COOL SET – the target Coolant temperature set point.
- PUMP – If the user presses the OFF soft key, a message will appear to confirm turning the pump off. When confirmed, the pump will turn off.
- RESUME TX – If the user presses YES, the Manual Controls panel will be displayed, and the treatment can resume.
- COOL END – If the user presses YES, a confirmation message will appear. If the user selects YES again to confirm, Cooldown will stop, and the treatment is ended (and cannot be resumed).

3.4.2.4 Control Panel: MESSAGE

During treatment, messages are displayed with a message panel.

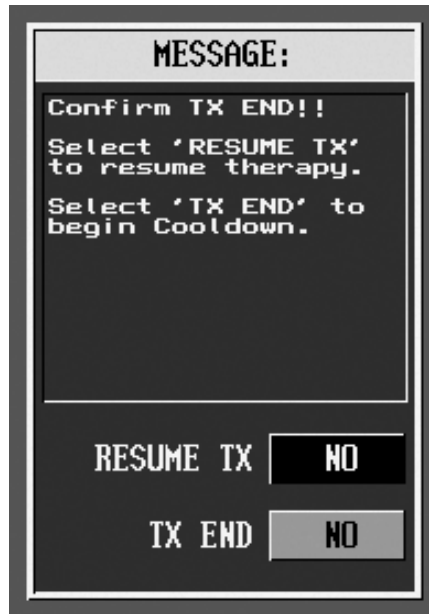

Figure 3-14: Message Panel

- RESUME TX – Pressing YES will return to the previous panel, pressing NO will have no effect.
- TX END – Pressing YES will end the treatment.

3.4.2.5 Control Panel: ERROR/WARNING

This panel is displayed to indicate an error or warning.

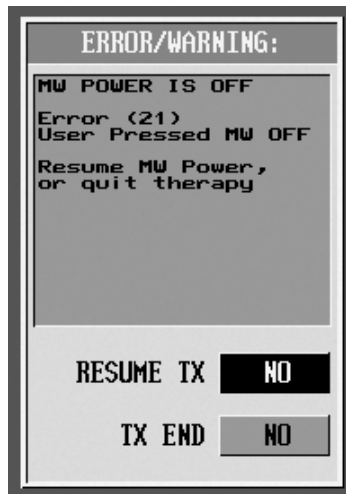

Figure 3-15: Error/Warning Panel

- RESUME TX – Pressing YES will return to the previous panel.
- END TX – pressing YES will exit the treatment mode and enter Cooldown.

3.4.2.6 Control Panel: EXIT COOLDOWN

This panel is displayed to indicate the user has selected “COOL END”:

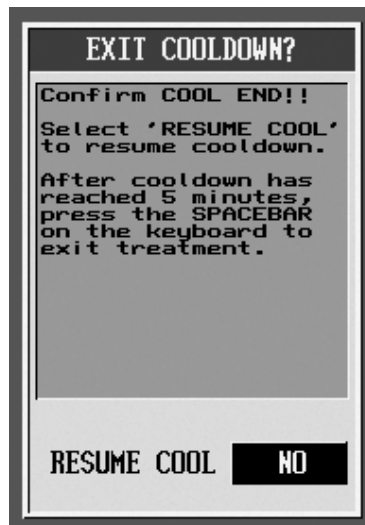

Figure 3-16: Exit Cooldown Panel

- RESUME COOL – Pressing YES will return to the previous panel.
- SPACEBAR – press the spacebar on the keyboard to exit treatment.



Note: After confirming this message with the spacebar, it is not possible to re-enter treatment without recalibration.

3.4.3 Automatic Treatment – “Cruise II”

In this mode, the Control Unit will automatically ramp the MDS temperature to the MDS set point, and the Coolant temperature to the coolant set point value of 8°C for the Targis MDS and 15°C for the Cooled ThermoCath MDS and the CTC Advance MDS. (These target values of MDS Set point and Coolant Set point can be changed at any time.) The initial ramp rate is chosen on the “Treatment Settings” screen.

 **Note:** If an error occurs during Cruise, the system will turn off MW Power, and revert to Manual Control.

The default set point values depend upon the MDS being used and are defined in the table below.

	Default MDS Set Point	Default Coolant Set Point
Targis Microwave Catheter	40°C	8°C
CTC Advance and Cooled ThermoCath Microwave Catheter	40°C	15°C

What will the Cruise II software do for me?

- It will ramp the MDS temperature and Coolant temperature to the desired set points.
- It will adjust the coolant set point to respond to RTU temperatures.
- It will discontinue the MW Power when the TX TIME has elapsed, and will automatically begin Cooldown.

The entire treatment can be described in three sections: Ramp, Treatment, Cooldown.

3.4.3.1 Section: Ramp

- The ramp will begin automatically when calibration has completed.
- MW Power will be applied automatically, according to the individual patient’s urethral temperature response. Cruise will ramp the MDS and Coolant temperatures to their set point values according to the Ramp Rate selection.
- Monitor the patient for discomfort, and adjust the Ramp Rate if necessary. The Ramp Rate can be reduced to “HOLD”, allowing the patient to “get used to” the current level of MW Power before continuing.
- Adjust the MDS and Coolant set points as desired. It is recommended to use the default MDS and Coolant set points.

3.4.3.2 Section: Treatment

- The “TX TIMER” will count up the amount of time elapsed when the criteria defined in section 3.4.1.6. are met.

- If the RTU temperature is nearing 41°C, the Status Panel title will change to STATUS: RTU. In this case, Cruise will automatically increase the temperature of the coolant (but not the displayed set point) to compensate.
- Adjust the TX TIME to select when Cruise will automatically stop MW Power.
- After TX TIME has expired, the Cruise will sound the “Hi-Lo-Hi” beep tones, and enter the Cooldown section.

3.4.3.3 If an Error/Warning occurs, read the message and respond accordingly.

Clear the message by selecting “RESUME TX” | “YES”. When the message is cleared, the Manual Controls panel will be active. Re-engage Cruise by the following procedure:

- Adjust “PWR SET” to ≥ 10 watts, preferably to a value 5 watts below the value when the error occurred. NOTE: check the TX graph for a display of MW Power history.
- Allow the MDS temperature to stabilize for approximately 30 seconds before engaging Cruise.
- Engage Cruise by selecting “CRUISE” | “ON”.
- Cruise is now running, using the current value of the MDS sensor as the set point.
- Adjust the MDS set point to the desired value.
- Cruise will ramp the MDS to the new set point at the rate defined by the RAMP RATE setting.

3.4.3.4 Section: Cooldown

- During this section, the user may choose to print the treatment listing.
- Continue pumping coolant until the Cooldown timer has reached 5 minutes.
- The “Hi-Lo-Hi” beep tones will sound, to remind the user that the time has expired.
- Select “COOL END” | “YES”, and press the spacebar to exit treatment and prepare for the next patient.

3.4.4 Manual Treatment – Express Protocol

In this mode, the user can adjust MW Power and Coolant manually. Maintain MDS and RTU temperatures within the appropriate limits for the prescribed time.

3.4.4.1 Section: Ramp

Verify that coolant set point is at the default value, and wait until the measured coolant temperature has reached \leq the default value +4°C before applying MW Power.

Step 1: Begin applying MW Power by adjusting the PWR SET to 20 watts.

- Wait 2 minutes. Use the Interval Timer as a guide for timing PWR SET adjustments.

Step 2: Continue to increase PWR SET by 5 watts at 2 minute intervals until:

- MDS $\geq 35^\circ\text{C}$ (TX TIMER will begin automatically, since the conditions for it to run should have been met.)
- OR RTU reaches 40°C

- OR: Patient comfort level is exceeded.

Step 3: When one of the above parameters is reached, increase power by 1 watt per minute until:

- MDS reaches $40.0 \pm 1^{\circ}\text{C}$
- OR : $\text{RTU} \geq 41.5^{\circ}\text{C}$
- OR: MW Power reaches 60 watts for a Targis or CTC Advance Short MDS or 75 watts for a Cooled Thermocath or CTC Advance Standard or Long MDS.
- OR: Patient comfort level is exceeded

3.4.4.2 Section: Treatment

A minimum of 28.5 minutes of treatment will begin at this point.

Throughout the treatment, carefully monitor patient discomfort levels and the MDS and RTU temperatures.

- Maintain the optimum MDS temperature of $40.0 \pm 1^{\circ}\text{C}$
- Should the RTU exceed 42.0°C , decrease power in 1 watt per minute increments until RTU is 41.5°C . If the RTU temperature does not respond as quickly as needed, decrease power by 3 watt increments as needed. When RTU temperature begins to decrease, try to increase power to achieve and maintain MDS at $40 \pm 1^{\circ}\text{C}$, while maintaining rectal temperature at or below 42.0°C .
- After at least 28.5 minutes of treatment (maximum of 60 minutes for a Targis MDS, 28.5 minutes for a Cooled Thermocath and CTC Advance MDS) select “TX END” | “YES”, The “Cool Controls” panel will be displayed.

3.4.4.3 Section: Cooldown

- During this section, the user may choose to print the treatment listing.
- Continue pumping coolant until the Cooldown timer has reached 5 minutes.
- The “Hi-Lo-HI” beep tones will sound, to remind the user that the time has expired.
- Select “COOL END” | “YES”, and press the spacebar to exit treatment and prepare for the next patient.

3.5 Terminate Treatment

1). After you press the spacebar on the EXIT COOLDOWN panel, the OPTIONS MENU will be displayed.

- 2). Disconnect the coolant Bag from the MDS. Be careful to keep the Coolant Bag inlet and outlet tubing above the handle of the Control Unit. This will prevent water from draining out of the Coolant Bag onto the floor. Alternatively, you could connect the Coolant Bag connectors to each other.
- 3). Disconnect the MDS from the Control Unit.
- 4). Remove all water from the location balloon and withdraw the MDS from the patient.
- 5). Remove all air from the RTU and withdraw the device from the patient.



Caution: Verify that the disposable components are removed intact.

- 6). Disconnect the RTU from the Control Unit patient connection cable. Turn the grey portion of the connector for ease of disconnection.
- 7). Remove the Coolant Bag from the Control Unit.
- 8). Dispose of the Single Use MDS, Single Use RTU or component, and Coolant Bag in accordance with Universal Precautions for contamination. Refer to section 4.1 for instruction on cleaning and disinfecting the reusable RTU Plus handle.
- 9). Print the treatment data or copy it to a floppy disk.
- 10). If you do not wish to copy the patient file to a floppy disk or print out the information, turn off the Control Unit by pressing the ON/OFF switch located on the right side of the unit (“o”). Hang the patient connection cable on the holder located on the Control Unit.
- 11). Cover the connectors at the end of the patient cable.
- 12). If no additional procedures are to be performed, disconnect the electrical cord of the unit from the wall outlet and roll the Control Unit to a storage location until the next procedure. Replace Control Unit cover.

3.6 Post-Procedure Treatment Options

Due to edema from thermal damage caused by the treatment to the prostate tissue, the prostate may swell and obstruct the urethra for a short period of time. For patient comfort, the physician may:

- Place a Foley Catheter before discharging the patient. The catheter may be removed within 2 to 5 days, or as the physician directs.
- Instruct the patient, at discharge, to take prophylactic oral antibiotics for 3 to 5 days.
- Provide the patient with sedatives, pain relievers, or anti-inflammatory medication as necessary.

3.7 Options

The Options Screen (figure 3-17) will be displayed after exiting a treatment, or by pressing the OPTIONS soft key on the Main Screen.

The Options Screen menu allows the following functions:

Copy a patient data file to a floppy diskette

Print a patient data file on the Control Unit printer

Format a diskette to prepare it for copying patient data

Adjust system settings

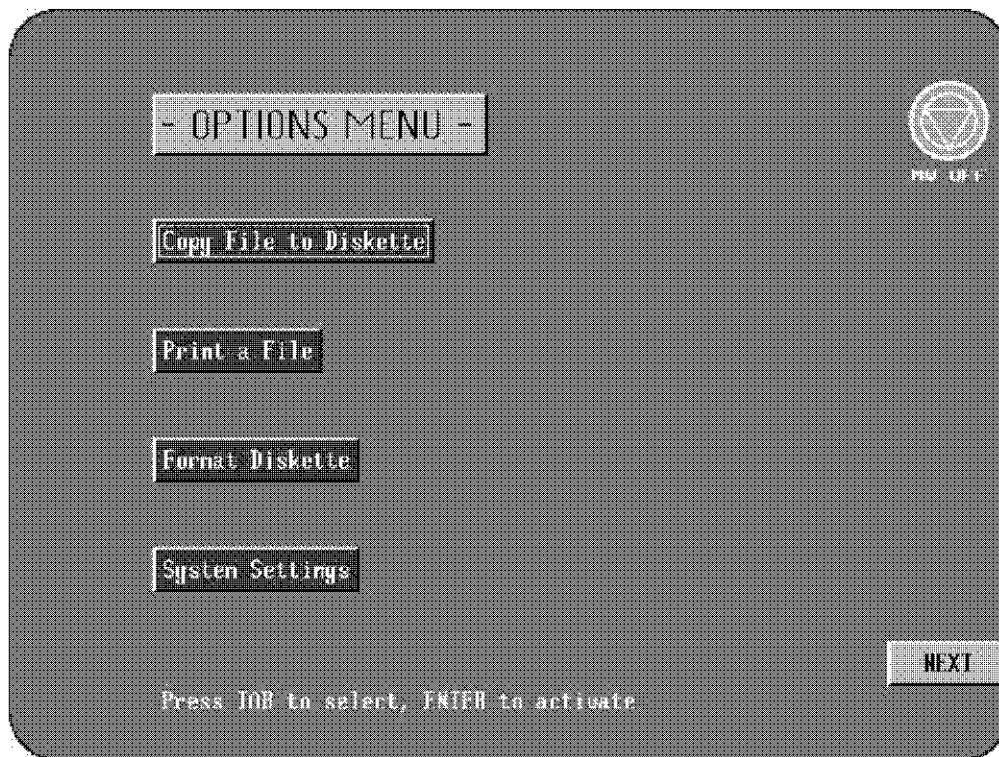

Figure 3-17: Options Screen

Select the desired function by pressing the TAB key on the Control Unit keyboard. A border highlighting the selected function will move between functions as the TAB key is pressed. After selecting the desired function press the ENTER key on the keyboard to activate the function.

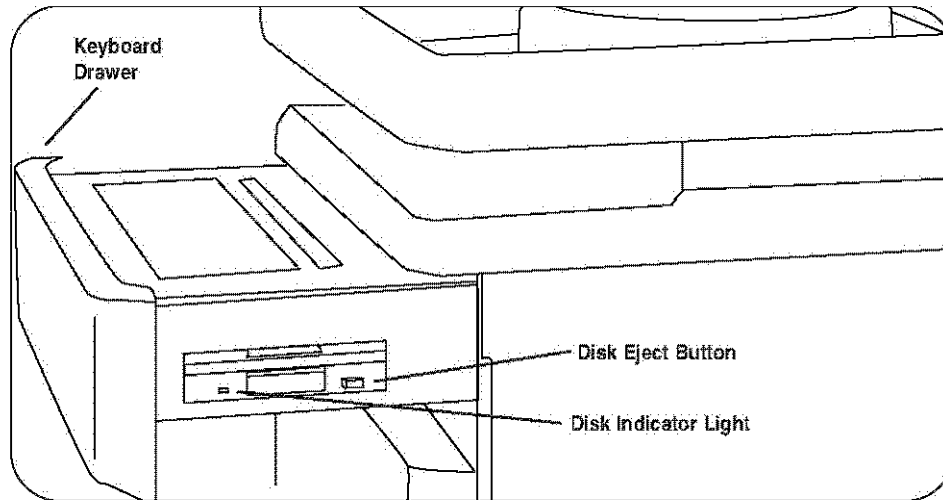

Figure 3-18: Floppy Disk Drive

3.7.1 Copy File to Diskette

You may copy a patient data file to a diskette (1.44 MB, DOS-formatted, 3.5 inch) using the following instructions:

1. Place the diskette into the floppy disk drive, located at the right side of the keyboard drawer (*figure 3-18*).
2. Make certain Copy File to Diskette function box is highlighted. If it is not, press the TAB key until it is highlighted.
3. Press the ENTER key. The Select File Pop-up Screen will appear.

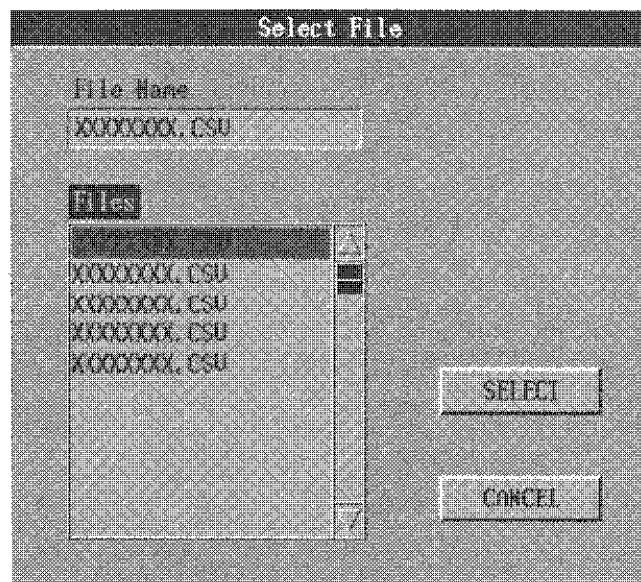



Figure 3-19: Select File Pop-up screen

- Using the TAB key, highlight the FILES box. Use the down [↓] and up [↑] cursor arrows to highlight the file to be copied. Press the ENTER key to select and copy the file. (Note: some keyboards may require the use of the Ω key to operate the cursors.)

 **Note:** If a treatment has just been completed, it will be automatically selected, and will skip to the Confirm Operation Pop-up Screen.

- Pressing the ENTER key to copy the file will display the Confirm Operation Pop-up Screen (*figure 3-20*) with the file name to be copied. Press the TAB key to select YES and press the ENTER key to copy the file. Press the TAB key to select NO and press the ENTER key to discontinue the copy function.

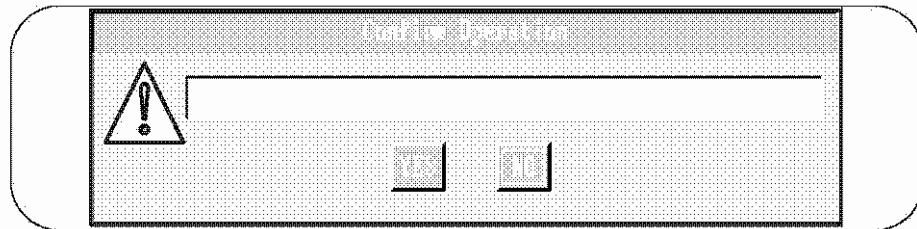

Figure 3-20: Confirm Operation Pop-up Screen

- To remove the diskette, press the DISK EJECT button (*figure 3-18*). Label the diskette with the name of the copied file.

3.7.2 Print a File

- Make certain the PRINT A FILE function box is highlighted. If it is not, press the TAB key until it is highlighted.
- Press the ENTER key. The Select File Pop-up Screen will appear (*figure 3-19*).
- Using the TAB key, highlight the DIRS/FILES box. Use the [↓] and up [↑] cursor arrows to highlight the file to be copied. Press the ENTER key to select and copy the file. (Note: some keyboards may require the use of the Ω key to operate the cursors.)
- Pressing the ENTER key to print the file will display the Confirm Operation Pop-up Screen (*figure 3-20*) with the file name to be printed. Press the TAB key to select YES and press the ENTER key to print the file. Press the TAB key to NO and press the ENTER key to discontinue the print function.
- The Control Unit reads from the hard disk and prints the data in the format shown. (*figure 3-21*).

```

UROLOGIX, Inc.
-----
- PATIENT DATA -

NAME: John Jones
ID#: 0123456789
MDS S/N:
RTU LOT: R00123
DATE: 25-AUG-2000
TIME: 02:29:02 PM
-----
- CLINICAL DATA -

PHYSICIAN: Dr. My Namehere
INSTITUTION:
IPSS:
QMAX:
QOL:
PSA:
URETHRA LENGTH:
PROSTATE VOLUME:
PVR:
DOB:
-----
- TREATMENT SUMMARY -

MAX POWER = 42.8 W
TOTAL ENERGY = 21.4 KJ
MAX MDS = 40.3 °C
MAX RTU = 37.8 °C
TREATMENT TIME = 28:30
RTU LOT = R00123
RTU USE = n/a
-----
- TREATMENT DATA -

```

TIME MIN	POWER WATTS	COOLANT TEMP °C	MDS TEMP °C	RECTAL TEMP °C
1	25.3	15.3	27.8	34.3
2	34.2	12.4	32.2	36.5
.				
.				
38	0.0	8.4	22.5	36.8

Figure 3-21: Treatment Printout

3.7.3 Format Diskette in Floppy Drive

If required, you may format a new diskette before copying a patient data file.

1. Place a diskette in the Control Unit floppy disk drive. Use the TAB key to select FORMAT DISKETTE function on the Options Screen (*figure 3-17*) and press the ENTER key.
2. The Confirm Format Disk Pop-up Screen will be displayed (*figure 3-22*). Press the TAB key to select YES and press the ENTER key to format the diskette. Press the TAB key to select NO and press the ENTER key to cancel the format operation.

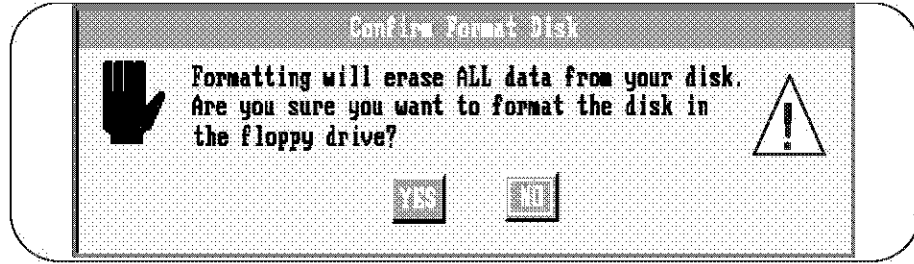

Figure 3-22: Confirm Format Disk Pop-up Screen

3. After formatting is confirmed with YES, the Formatting Disk Pop-up Screen (*figure 3-23*) will display the formatting status.

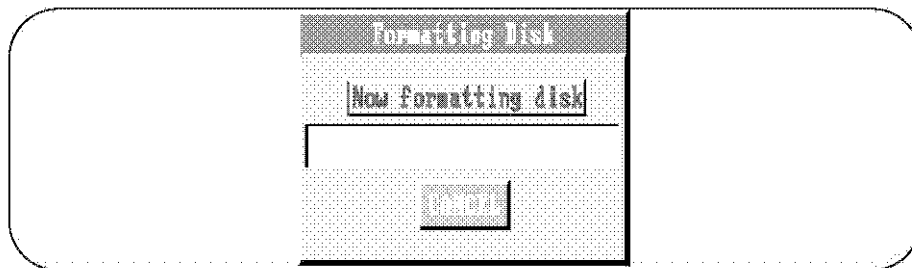

Figure 3-23: Formatting Disk Pop-up Screen

4. After the floppy disk drive active indicator light goes off, remove the floppy disk and label it as formatted.

3.7.4 Adjust System Settings

The System Settings Screen allows you to adjust the control Unit system settings.

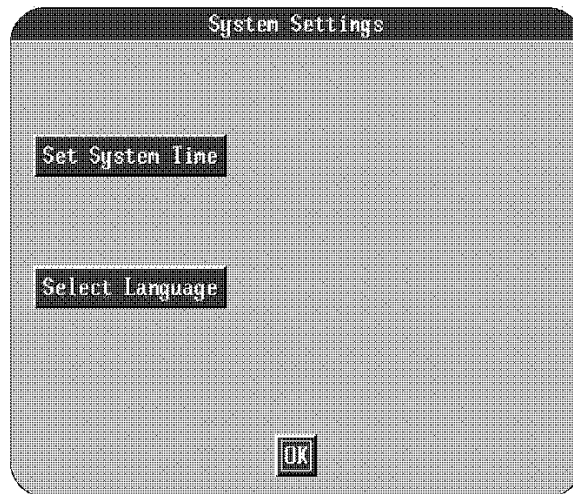

Figure 3-24: System Settings Screen

3.7.4.1 Set Control Unit Time and Date

1. If the Control Unit time or date are incorrect, they can be changed. Press the TAB key to Set system Time on the System Settings Screen (*figure 3-24*) and press the ENTER key. At this point the Set Date and Time Pop-up screen (*figure 3-25*) will be displayed.
2. Check the date and time displayed. If the time is incorrect, press the TAB key to CHANGE TIME and press the ENTER key. This will display the Set Time Pop-up Screen (*figure 3-26*).

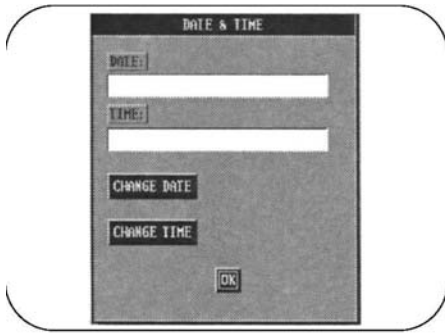

Figure 3-25: Set Date and Time Pop-up Screen

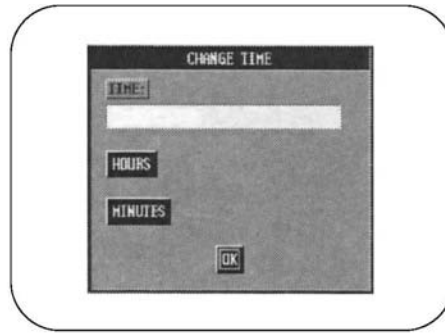

Figure 3-26: Set Time Pop-up Screen

3. TAB to the HOURS and correct the setting by pressing the ENTER key. Each time the ENTER key is pressed the value will increase by 1.
4. Next, TAB to MINUTES and follow the same steps as setting the hours.
5. After the time is set correctly TAB to the OK and press the ENTER key. This will return the display to the Set Date and Time Pop-up Screen (*figure 3-25*).
6. To set the date, TAB to the CHANGE DATE on the Set date and Time Pop-up screen (*figure 3-25*) and press the ENTER key. This will display the Set Date Pop-up Screen (*figure 3-27*).

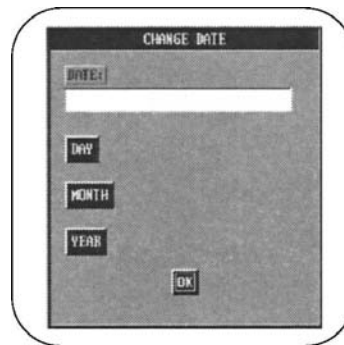

Figure 3-27:
Set Date Pop-up Screen

7. TAB to DAY and press the ENTER key. Each time the ENTER key is pressed the day will increase by 1.
8. TAB to the MONTH and press ENTER to cycle through the months.
9. TAB to the YEAR and press ENTER to increase the year. Each time the ENTER key is pressed the year will increase by 1 until 2020 and then it will start over at 1990.
10. TAB to OK and press ENTER to exit. This will return you to the Set Date and Time Pop-up Screen (*figure 3-25*).

11. Tab to the OK on the Set Date and Time Pop-up screen and press ENTER to return to the Options Menu Screen (*figure 3-17*).

3.7.4.2 Select a Language

The Targis System user software is only available in English.

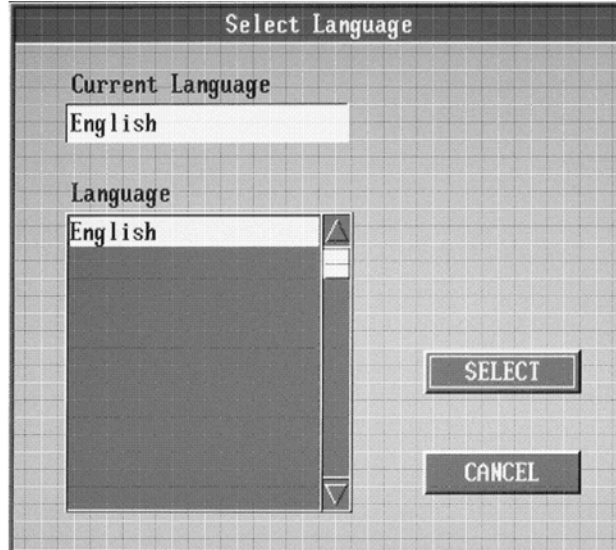

Figure 3-28: Language Screen

3.7.5 Options Errors

If an options error occurs, the Options Error Pop-up Screen (*figure 3-28*) will be displayed. If this screen is displayed refer to Section 5: Troubleshooting Guide action steps to correct the error.

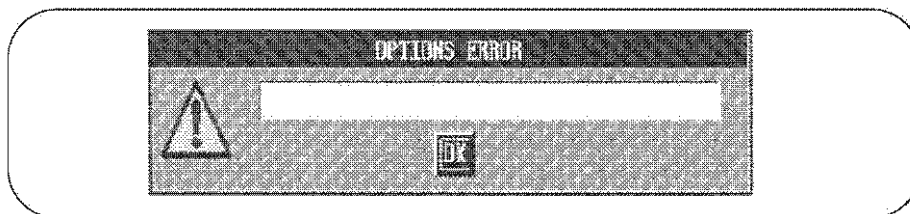

Figure 3-29: Options Error Pop-up Screen

3.8 MW OFF Soft Key

The MW OFF soft key appears on all screens. Press the MW OFF soft key if:

The microwave power indicator is illuminated when microwave power has not been intentionally applied.

The patient reports pain and there is no apparent reason.

The Control Unit will respond by discontinuing microwave power and turning off the microwave power indicator light. Coolant will continue to circulate if it is on. During screens when microwave power could be applied to the patient (Calibration Progress, Coolant Adjust, Microwave Power Adjust, Pump On/Off, Confirm Pump Off, End Treatment and Confirm End Treatment), there will be a screen response when the soft key is pressed. See section 5, Troubleshooting Guide, error numbers 21 and 104, for the action steps to be taken. Turn off the Control Unit and call Urologix customer Service at 1-888-229-0772.

3.9 Targis System Errors

3.9.1 Calibration Errors

Errors during the Targis System calibration are displayed on the Calibration Halted Screen (figure 3-30).

If any disposable needs to be replaced, press the REPLACE soft key and enter the new serial or lot number on the Patient Data Display Screen. Resume calibration by pressing the NEXT soft key twice to return to the Calibration Progress Screen, or press REPEAT to retry the halted calibration step, or press MAIN to return to the Main Menu Screen.

Note: If you press the MAIN soft key, you must reenter all the information in the Patient Data Display screen.



Figure 3-30: Calibration Halted Screen

Warning: If one of these messages appears, refer to Section 5, Troubleshooting Guide in this Manual for more information.

In most cases, error messages will appear on the display screen because the Control Unit failed to read or detect the MDS temperature sensor, RTU temperature sensors, MDS antenna connection, or Coolant Bag pressure during the calibration cycle. Normally, to correct the problem you can readjust the appropriate connector to the component and then press the REPEAT soft key to restart the cycle.

3.9.2 Treatment Errors

If an error occurs during the treatment session, read the message in the ERROR/WARNING Panel and follow those instructions. See Section 5, Troubleshooting Guide for other possible causes and action steps to be taken if an error is present. Errors will set the microwave power to zero and, in some cases, turn off the MDS coolant pump.



Warning: If one of these messages appears, refer to Section 5, Troubleshooting Guide in this Manual for more information.

After correcting the cause of the error, select “RESUME TX” | “YES”. This will clear the error and allow the treatment to resume.

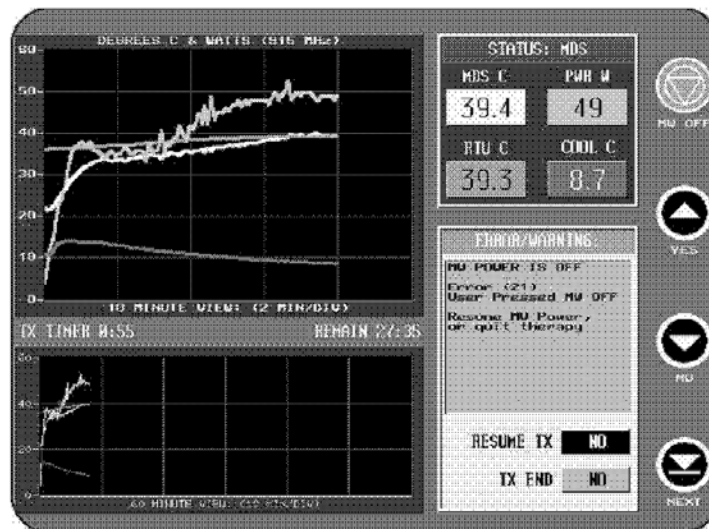

Figure 3-31: Treatment Error Message Panel

3.9.3 System Halt Errors

If the Control Unit discovers a significant problem, it automatically shuts itself down. If this occurs, the System Halt Screen (*figure 3-32*) will be displayed.

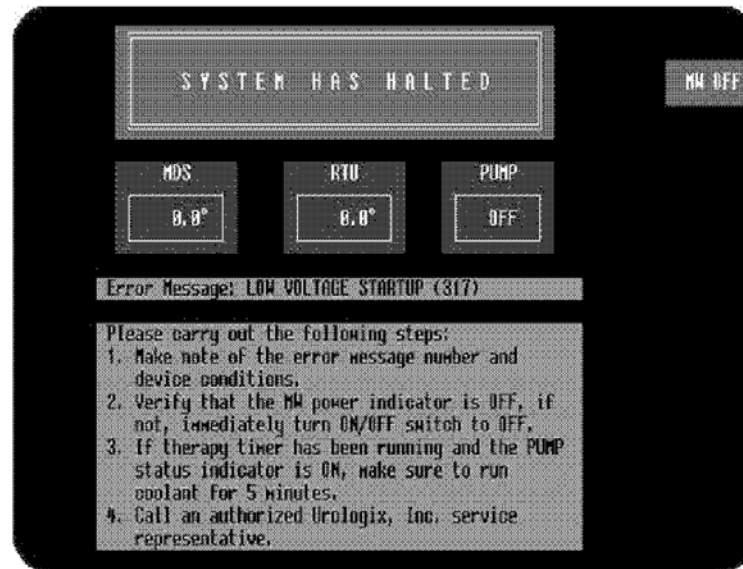

Figure 3-32: System Halt Screen

If this message appears, do the following:

Save Error Message printout

Do not continue the treatment

Run the Control Unit for 5 minutes to cool the patient's urethra

Power down the Control Unit

Call Urologix Customer Service at 1-888-229-0772 with error printout available.

4.1 Post-Treatment Cleaning Procedures

The following process can be used to clean and disinfect the RTU Plus Handle (containing the temperature sensors) for subsequent use. The RTU Plus handle should not be used more than 30 times.

1. Remove and discard the disposable rectal balloon if not already discarded.
2. It is recommended that a glove be tied over the rectal unit cable connector to prevent it from being splashed or soaked.
3. Rinse the rectal unit handle with warm running tap water until all or most visible gross debris is removed. Avoid any water contact with the connector. Gently shake to remove excess water.
4. Place the RTU Plus handle in a bath with water and enzymatic detergent (e.g., ENZOL) mixture diluted according to the manufacturer's instructions (typically 1 oz ENZOL per gallon of water) for 2 minutes. **Do not soak or immerse the connector.** After soaking 2 minutes, clean the crevices with a soft bristle brush. Pay special attention to the temperature sensor "flex circuit" bend points, sensor/handle junction, and inflation tubing channel to avoid damage and to ensure adequate cleaning.
5. Rinse the rectal unit handle for 2 minutes using warm tap water. Gently shake to remove excess water and to avoid splashing or casting of solution.
6. Inspect the rectal unit handle under standard lighting to verify that all soil was removed. If not, repeat above steps.
7. Rinse the rectal unit handle with deionized water to remove any excess residues left by the tap water. Gently shake to remove excess water and to avoid splashing or casting of solution.
8. Soak the rectal unit handle (again, **do not soak or immerse the connector**) in a 3.4% glutaraldehyde solution according to the manufacturer's instructions.
9. After soaking, rinse devices per manufacturer's instructions (typically 3 separate 1-minute soaks in copious volumes of deionized water).
10. Gently dry the RTU Plus handle. Store in dry, ambient conditions between 59°F - 95°F (15°C - 35°C) until the next use. Always avoid bending the temperature sensor strip significantly.

There are no special clean-up operations required after a Cooled ThermoTherapy Treatment for the Control Unit. If a product failure occurs, the defective device must be returned to Urologix for evaluation and reimbursement.

The Control Unit exterior should be cleaned periodically following these instructions:

Clean the exterior surface of the Control Unit with a soft, lint-free cloth dampened with warm water and a diluted detergent, 10% dilution of bleach, or a diluted, nonabrasive, non-staining standard hospital disinfectant. Use a lint-free cloth dampened with warm water to rinse the surface of the unit.

Do NOT use isopropyl alcohol (IPA) to wipe the exterior Control Unit or display screen. Using cleaning solvents such as IPA could result in damage to the Control Unit.

Storage Instructions

For short and long-term storage, handle the Targis Control Unit as you would other sensitive medical equipment. Store the Control Unit in a low-moisture equipment storage area where it may be kept long-term. Keep the surfaces and components of the Control Unit free of dust by covering the unit with its cover or plastic.

4.2. Equipment Moving Instructions

When moving the Targis Control Unit, grip the handle at the top of the unit. This handle is designed for moving, and one person should be able to push or pull the unit with little effort.

The wheels of the unit pivot to assist you when you wish to turn the unit in a new direction. The front wheels have an individual lock you can use when the unit is stationary. To lock the wheels, use your foot to press down on the front part of the wheel lock tabs. To unlock the wheels, press on the back part of the wheel lock tab.

Observing Proper Safeguards

Several safeguards or cautions apply when you need to move the Control Unit. They are as follows:

Protect the patient connection cable when you move the system. Although a storage hook is provided on the handle for the patient connection housing, the cable is still susceptible to damage.

Maintain the system in an upright position when it is in use or being stored.

Avoid tipping the unit. Since the system is heavy, it will be damaged if it were to tip over. In addition, personal injury could result.

Do not lift or elevate the Control Unit.

Equipment Shipping Instructions

In the event that it becomes necessary to ship the Targis Control Unit, contact Urologix Customer Service at 1-888-229-0772.

For repeated transportation of the Targis Control Unit, Urologix offers a Targis Transportable Kit which is the only FDA-approved method for transporting the Targis System.

4.3 Operator Inspection

Before using the Targis system, operators should visually inspect the following components for damage. Examine:

Control Unit for obvious damage

Pump latch and coolant door to see that they are operating correctly

Patient connection cable, cable connection housing, and connectors for kinks, cuts, dirt, contamination, or obvious damage

Microwave Catheter for kinks, cuts, or obvious damage

Rectal Thermosensing Unit for kinks, cuts, or obvious damage

Coolant Bag for kinks, cuts, or obvious damage

Daily Maintenance

1. Wipe the exterior surface of the Control Unit with a 10% solution of bleach or mild detergent. Wipe with water to rinse.
2. Check the printer paper and refill is necessary (see Printer Maintenance, Section 4.4)
3. Check all cables and power connections. Be certain that all cables are firmly attached and routed away from normal traffic paths.
4. Check the sight gauge on the left side of the Control Unit to ensure that the internal coolant level is within the white open section of the correct level indicator (*Figure 4-1*).

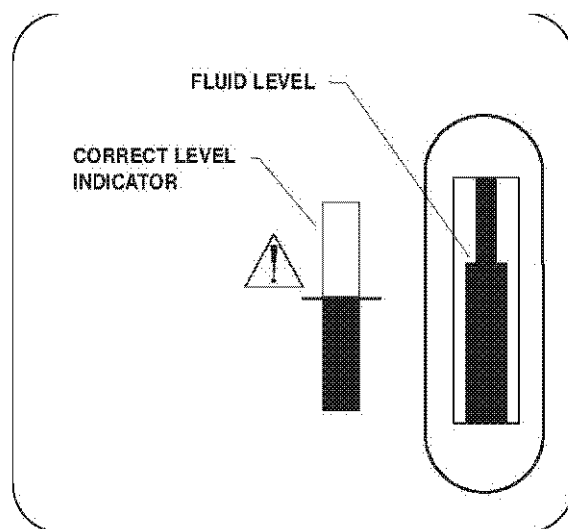

Figure 4-1. Internal Coolant Level Indicator

Periodic Maintenance

Preventive maintenance should be performed each year by a Urologix trained and authorized service representative. Contact Urologix Customer Service if more than 12 months have passed since the last preventive maintenance.

Service and maintenance of equipment must be performed only by trained and authorized personnel from Urologix or its distributors. Any other type of service and maintenance arrangement will void all warranties and claims.

4.4 Printer Maintenance

Printer maintenance consists of changing paper when needed and cleaning the printer periodically.

4.4.1 Changing Paper in the Printer

You can order replacement paper for the printer from Urologix. Follow these steps to replace the paper:

1. Press down on printer door to release the latch and lift the door open.

2. Remove the old roll from the paper well.
3. Place the paper roll in the paper well. Note: Thermal paper must roll out from the bottom of the paper roll.
4. Cut the end of the new paper square.
5. Push the paper into the printer. The printer will feed the paper using its automatic feed. After the printer feeds the paper, advance approximately 3 inches of paper out the top of the printer, using the Paper Feed Button (*figure 4-2*).
6. Feed the paper through the paper slot in the printer door.
7. Close and latch the printer door.

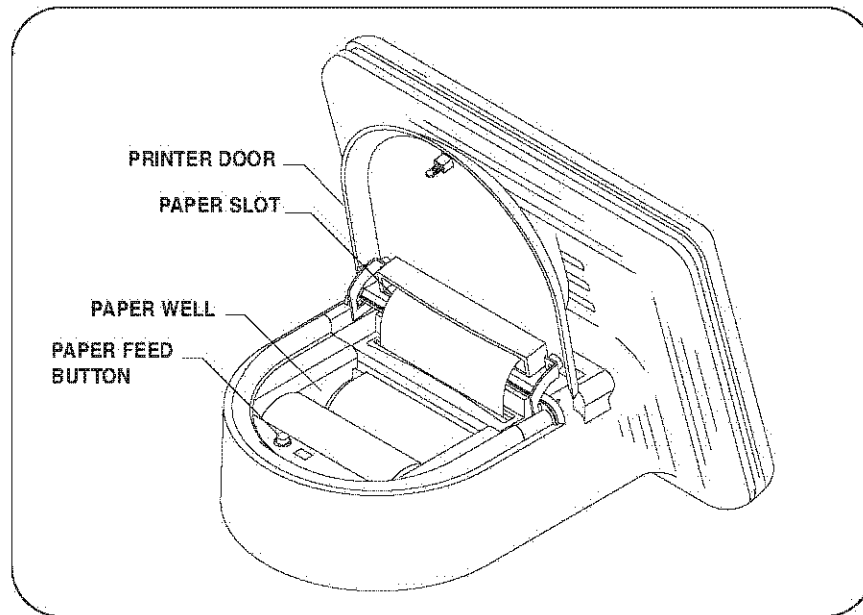

Figure 4-2: Loading Paper in Printer

4.4.2 Printer Cleaning

Printer cleaning must be performed by trained service personnel, using the instructions in the Targis Control Unit Service Manual.

4.5 Fuse Replacement

1. Using a flat screwdriver, remove the fuse holder caps (*figure 4-3*).

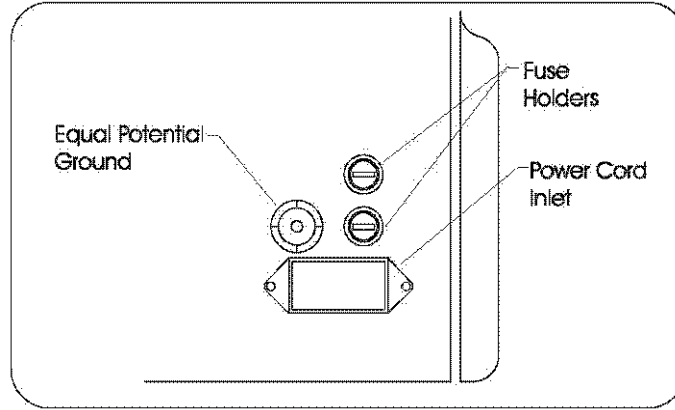



Figure 4-3: Targis Control Unit Rear Cover

2. Replace the defective fuses with the appropriate Urologix fuses listed below:





Control Unit Model	Fuse Catalog Number	Fuse Type/Rating
Model 4000A	AC1008	1 1/4" x 1/4" / 10 A
Model 4000E	AC1009	5 mm x 20 mm / 5 A

3. Replace the Fuse Holders.

 **Warning:** Only replace Targis Control Unit fuses with Urologix supplied components.

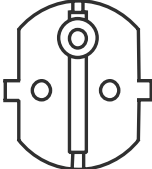
4.6 Targis Control Unit Power Cords

Urologix provides the following power cords to be used with the Targis Control Unit.

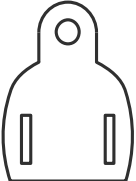
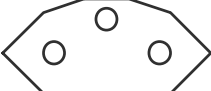
End View	Power Cord Catalog Number
	Catalog Number: AC1011 France Austria Germany Norway Belgium Sweden Netherlands Finland
	Catalog Number: AC1012 Australia New Zealand
	Catalog Number: AC1013 United Kingdom Ireland
	Catalog Number: AC1014 Denmark
	Catalog Number: AC1015 Italy
	Catalog Number: AC1017 Canada United States Mexico
	Catalog Number: AC1018 Switzerland

4.7 Targis Control Unit Specifications

Targis Control Unit Models:	4000E (Europe) 4000A (US)
Power Requirements:	4000E: 220/240 V [$\pm 10\%$] (4.25 A) Single phase 50 or 60 Hz 4000A: 110/120 V [$\pm 10\%$] (8.5 A) Single phase 50 or 60 Hz
Microwave Output:	Power: 0 W-75 W output from the microwave antenna connector on the patient cable, continuous duty Frequency: 902 MHz to 928 MHz
Coolant Circulation System:	Chill Element: Thermoelectric Capacity: 100 W element Configuration: Disposable Coolant Bag Bag Dimensions: Approximately 15.2 cm x 17.8 cm Bag Capacity: Approximately 100 mL Pump: Peristaltic pump
User Interface:	Display: Color LCD Input: Soft keys menus Keyboard: Silicone rubber keyboard
Operating Conditions:	Temperature: $+10^{\circ}\text{C}$ to $+30^{\circ}\text{C}$ Humidity: 30% to 75% relative humidity Atmospheric Pressure: 700 hPa to 1,060 hPa
Class/Type:	IEC 60601-1 Class I, Type BF with defibrillation protection
Measurements Range and Accuracy:	RTU: Range 1°C to 50°C , Accuracy 1°C from 35°C to 45°C and 2°C outside this range MDS: Range 27°C to 47°C , Accuracy $\pm 1^{\circ}\text{C}$ MDS Coolant Temperature: Range -25°C to 75°C , Accuracy $\pm 3^{\circ}\text{C}$ Microwave Power: Range 0 W-75 W, Accuracy $\pm 10\%$

5.1. Troubleshooting Guide

#	Problem Message	Possible Causes	Action Steps
1	MW POWER IS OFF RTU Temp. High (1)	1. Loose connector. 2. Temperature in rectum has exceeded 42.5°C. 3. RTU may be defective. 4. Air may not have been removed from the original volume (cc's) in the RTU. 5. Enema not performed within 2 hours of treatment. 6. RTU may not be inserted properly. 7. Patient inaccurately positioned. 8. MDS may not be positioned properly.	1. Reattach connectors. 2a. Allow rectal temperature to drop below 42°C. 2b. Restart system at 5 watts below previous microwave power setting. 3. Replace RTU. 4. Remove air per section 2.10 or 2.11. 5. Remove RTU and perform enema. 6. Check that the RTU is properly positioned. 7. Reposition patient with head and shoulders elevated no higher than a 20° angle. 8. Check that the MDS is properly positioned. (Resume microwave power.)
2	MW POWER IS OFF RTU Temp. Low (2)	1. Loose connector. 2. RTU temperature below 31° C. 3. RTU may be defective. 4. RTU expelled or not properly inflated. 5. RTU may not be inserted properly.	1. Reattach connectors. 2a. Check that RTU is inserted properly. 2b. Restart system at previous microwave power setting. 3. Replace RTU. 4. Reinsert RTU or inflate RTU. 5. Check that RTU is properly positioned. (Resume microwave power.)
3	MW POWER & PUMP ARE OFF Coolant Pressure High (3)	1. Pressure too high in tubing. 2. Coolant Bag may be defective. 3. MDS may be defective.	1a. Check water level in the Coolant Bag. 1b. Check for tubing kink. 1c. Check that pump tubing clamp is properly fastened. 2. Turn pump off, verify pump is off. Disconnect coolant luers from MDS and connect coolant luers to each other, then restart pump. If error repeats, replace coolant bag. 3. Turn off pump, verify pump is off. Disconnect coolant luers from MDS and flush MDS coolant luers with sterile water. Reconnect coolant bag luers to MDS and restart pump. If error repeats, replace MDS. (Resume microwave power.)

#	Problem Message	Possible Causes	Action Steps
4	MW POWER IS OFF Coolant Pressure Low (4)	<ol style="list-style-type: none"> 1. Pressure is too low in the tubing. 2. Coolant Bag may be defective. 3. MDS may be defective. 4. Coolant tubing between coolant bag and sensor module may be twisted. 5. Microwave power and pump are off. 	<ol style="list-style-type: none"> 1a. Check water level in the Coolant Bag. 1b. Reattach pump tubing clamp. 1c. Check that pump tubing clamp is properly fastened. 2. Replace Coolant Bag. 3. Replace the MDS. 4. Verify tubing is not twisted. 5. Manually irrigate and contact Urologix Customer Service (Resume microwave power.)
5	MW POWER IS OFF MDS Temp. High (5)	<ol style="list-style-type: none"> 1. Loose MDS fiber connector. 2. Temperature in urethra > 44.5° C. 3. MDS may be defective. 	<ol style="list-style-type: none"> 1a. Reattach fiber connector. 1b. Clean both ends of connection with alcohol wipe or swab. 2a. Allow MDS temperature to drop ≤41° C. 2b. Restart system at 5 watts below previous microwave power setting. 3. Replace the MDS. (Resume microwave power.)
6	MW POWER IS OFF MDS Temp. Low (6)	<ol style="list-style-type: none"> 1. Loose MDS fiber connector. 2. MDS temperature is < 5°C. 3. MDS may be defective. 	<ol style="list-style-type: none"> 1a. Reattach connector. 1b. Clean both ends of connection with alcohol wipe or swab. 2. Restart system at a previous microwave power setting. 3. Replace MDS. (Resume microwave power.)
7	MW POWER IS OFF MDS Efficiency Low (7)	<ol style="list-style-type: none"> 1. Cable may not be connected properly. 2. MDS may not be inserted properly. 3. Defective MDS. 4. Urine drainage line not purged. 	<ol style="list-style-type: none"> 1. Reattach connector. 2. Check that MDS is inserted properly. 3. Replace MDS and recalibrate. Re-enter patient information. 4. Purge urine drainage line. (Resume microwave power.)
8	MW POWER IS OFF Control Unit Temp High (8)	<ol style="list-style-type: none"> 1. Control Unit vents blocked. 2. Control Unit internal temperature ≥ 55°C. 3. System not operating properly. 	<ol style="list-style-type: none"> 1. Remove any item blocking vents. 2. Restart system at the previous microwave power setting. 3. If system fails again call Urologix Customer Service. (Resume microwave power.)
9	MW POWER IS OFF Control Unit Temp Low (9)	<ol style="list-style-type: none"> 1. Control Unit internal temperature broken. 	<ol style="list-style-type: none"> 1. Call Urologix Customer Service.

Troubleshooting

Section 5

#	Problem Message	Possible Causes	Action Steps
10	MW POWER IS OFF Amplifier Temp. High (10)	<ol style="list-style-type: none"> 1. Control Unit vents are blocked. 2. Microwave amplifier temperature is greater than the allowed value. 	<ol style="list-style-type: none"> 1. Remove any item blocking vents. 2a. Restart system at the previous microwave power setting. 2b. If system fails again call Urologix Customer Service. (Resume microwave power.)
11	MW POWER IS OFF Coolant Temp. High (11)	<ol style="list-style-type: none"> 1. Coolant temperature >40°C. 2. Coolant Bag may be defective. 3. Coolant door open. 	<ol style="list-style-type: none"> 1a. Check water level in the Coolant Bag. 1b. Check for tubing kink. 1c. Check that pump tubing clamp is properly fastened. 2. Replace the Coolant Bag. 3. Close coolant door. (Resume microwave power.)
12	MW POWER IS OFF Coolant Temp. Low (12)	<ol style="list-style-type: none"> 1. Coolant temperature is too low. 2. Coolant Bag may be defective. 3. Coolant door open. 	<ol style="list-style-type: none"> 1. Check water level in the Coolant Bag. 1b. Check for tubing kink. 1c. Check that pump tubing clamp is properly fastened. 2. Replace the Coolant Bag. 3. Close coolant door. (Resume microwave power.)
13	MW POWER IS OFF RTU Temp. High (13)	<ol style="list-style-type: none"> 1. Loose connector. 2. Temperature in the rectum > 42°C. 3. RTU may be defective. 4. Air may not have been removed from the original volume in the RTU. 5. Enema not performed within 2 hours of treatment. 6. RTU may not be inserted properly. 7. Patient inaccurately positioned. 8. MDS may not be positioned properly. 	<ol style="list-style-type: none"> 1. Reattach connector. 2a. Allow RTU temperature to drop below 42°C. 2b. Restart system at 5 watts below previous microwave power setting. 3. Replace RTU. 4. Remove Air per section 2.10 or 2.11. 5. Remove RTU and perform enema. 6. Check that the RTU is properly positioned. 7. Reposition patient with head and shoulders elevated no higher than a 20° angle. 8. Check that the MDS is properly positioned (Resume microwave power.)

#	Problem Message	Possible Causes	Action Steps
14	MW POWER IS OFF RTU Temp. Low (14)	<ol style="list-style-type: none"> 1. Loose connector. 2. RTU temperature < 15°C. 3. RTU may not be inserted in the rectum. 4. RTU may be defective. 5. RTU expelled or not properly inflated. 6. RTU may not be inserted properly. 	<ol style="list-style-type: none"> 1. Reattach connector. 2. Restart system at previous microwave power setting. 3. Check that RTU is inserted properly. 4. Replace RTU. 5. Reinsert RTU or inflate RTU. 6. Check that RTU is properly positioned. <p>(Resume microwave power.)</p>
15	MW POWER & PUMP ARE OFF Coolant Pressure High (15)	<ol style="list-style-type: none"> 1. Pressure in tubing is too high. 2. Coolant Bag may be defective. 3. MDS may be defective. 	<ol style="list-style-type: none"> 1a. Check water level in Coolant Bag. 1b. Check for tubing kink. 1c. Check that pump tubing clamp is properly fastened. 2. Turn pump off, verify pump is off. Disconnect coolant luers from MDS and connect coolant luers to each other, then restart pump. If error repeats, replace coolant bag. 3. Turn off pump, verify pump is off. Disconnect coolant luers from MDS and flush MDS coolant luers with sterile water. Reconnect coolant bag luers to MDS and restart pump. If error repeats, replace MDS. <p>(Resume microwave power.)</p>
16	MW POWER IS OFF Coolant Pressure Low (16)	<ol style="list-style-type: none"> 1. Pressure is too low in the tubing. 2. Coolant Bag may be defective. 3. MDS may be defective. 4. Coolant tubing between coolant bag and sensor module may be twisted. 5. Microwave power and pump are off. 	<ol style="list-style-type: none"> 1a. Check water level in Coolant Bag. 1b. Check for tubing kink. 1c. Check pump tubing clamp to ensure it's properly fastened. 2. Replace Coolant Bag. 3. Replace MDS. 4. Verify tubing is not twisted. 5. Manually irrigate and contact Urologix Customer Service. <p>(Resume microwave power.)</p>

Troubleshooting

Section 5

#	Problem Message	Possible Causes	Action Steps
17	MW POWER IS OFF MDS Temp. High (17)	<ol style="list-style-type: none"> 1. Loose connector. 2. Temperature in the urethra > 47°C. 3. MDS may be defective. 	<ol style="list-style-type: none"> 1a. Reattach fiber connector. 1b. Clean both ends of connection with alcohol wipe or swab. 2a. Allow MDS temperature to drop < 41°C. 2b. Restart system at 5 watts below previous microwave power setting. 3. Replace the MDS. <p>(Resume microwave power.)</p>
18	MW POWER IS OFF MDS Temp. Low (18)	<ol style="list-style-type: none"> 1. Loose connector. 2. MDS is < 5°C. 3. MDS may be defective. 	<ol style="list-style-type: none"> 1. Reattach connector. 2. Restart system at a previous microwave power setting. 3. Replace MDS. <p>(Resume microwave power.)</p>
19	MW POWER IS OFF MDS Efficiency Low (19)	<ol style="list-style-type: none"> 1. Cable may not be connected properly. 2. MDS may not be inserted properly. 3. MDS may be defective 4. Urine drainage line not purged. 	<ol style="list-style-type: none"> 1. Reattach the connector. 2. Check that MDS is inserted properly. 3. Replace the MDS and recalibrate. Re-enter patient information. 4. Purge urine drainage line. <p>(Resume microwave power.)</p>
20	MW POWER & PUMP ARE OFF Pump Latch Open (20)	<ol style="list-style-type: none"> 1. Coolant pump clamp latch is open or lift lever has failed. 	<ol style="list-style-type: none"> 1a. Close the latch. 1b. Restart the system at the previous microwave power setting. 1c. Open and close lift lever and listen for two clicks.

Section 5

Troubleshooting

#	Problem Message	Possible Causes	Action Steps
21	MW POWER IS OFF User pressed MW OFF (21)	<ol style="list-style-type: none"> 1. User accidentally pressed the soft key. 2. Patient was experiencing pain. 3. Microwave indicator was illuminated when it should not have been. 	<ol style="list-style-type: none"> 1. If the key was pressed accidentally, restart the system at the previous microwave power setting. 2. Restart system and input microwave power to an acceptable setting lower than previous setting. 3. Press NEXT soft key to advance to the End Treatment Screen. Press QUIT soft key, confirm with YES and turn off Control Unit. Call Urologix Customer Service.
22	MW POWER IS OFF RTU Disconnected (22)	<ol style="list-style-type: none"> 1. RTU has become disconnected from the patient cable. 	<ol style="list-style-type: none"> 1a. Reattach the connectors. 1b. Restart the system at previous microwave power setting. 1c. If system fails again, call Urologix Customer Service.
23	MW POWER IS OFF MDS signal weak (23)	<ol style="list-style-type: none"> 1. Fiber optic connector may be improperly connected or contaminated. 2. MDS may be defective. 3. Fiber optic cable may be broken. 	<ol style="list-style-type: none"> 1a. Disconnect and reconnect MDS optical fiber connector on patient connection cable. 1b. Press REPEAT soft key. 1c. If 1b does not solve problem, disconnect optical fiber connector and clean with isopropyl alcohol and swab. 1d. Reconnect MDS optical fiber connector on patient connector cable and press REPEAT soft key. 1e. If this doesn't work, go to Step 2 below. 2a. Replace MDS. 2b. Press REPEAT soft key. 2c. Enter new MDS serial #. 2d. Press NEXT soft key. 2e. Record on Device Return Form that new MDS has been installed. 3. Turn off Control Unit. Call Urologix Customer Service.

Troubleshooting

Section 5

#	Problem Message	Possible Causes	Action Steps
50	CAUTION: Treatment Time > 60 min (50)	1. TREATMENT timer has exceeded 60 minutes.	1. Press MW END to discontinue microwave power. Wait 5 minutes and QUIT Treatment.
51	CAUTION: MW Duration > 100 min (51)	1. One hundred minutes have elapsed since completing calibration.	1. Press MW END to discontinue microwave power. Wait 5 minutes and QUIT Treatment.
52	CAUTION: MDS Temp. > 41° C (52)	1. MDS temperature > 41°C.	1. Reduce microwave power until the MDS temperature is between 39°C and 41°C.
53	CAUTION: Run Coolant 5 min (53)	1. Five minutes have not elapsed since microwave power was discontinued.	1a. Wait 5 minutes with the microwave power at zero. 1b. Press YES to confirm.
54	CAUTION: Cruise unavailable (54)	1. Cruise Control is unable to be engaged.	1a. The current MDS temperature needs to be between 35°C and 40°C. 1b. MW power needs to be ≥10 watts.
55	REMINDER: Interval Elapsed (55)	1. Two minutes have elapsed since the last time MW power was adjusted.	1. Increase MW power per protocol.
56	CAUTION: RTU Temp.> 42°C.(56)	1. RTU temperature has exceeded 42°C.	1. Drop the MW power to lower the RTU temperature less than 42°C.

Section 5

Troubleshooting

#	Problem Message	Possible Causes	Action Steps
100	Calibration halted by the RTU (100)	<ol style="list-style-type: none"> 1. Temperature measurements in the RTU are not being received by the Targis Control Unit. 2. RTU may be < 31°C. 3. RTU may be defective. 4. RTU may not be properly positioned. 5. RTU expelled or not properly inflated. 	<ol style="list-style-type: none"> 1a. Disconnect and reconnect RTU connector on patient cable. 1b. Press REPEAT soft key. If this doesn't correct problem, replace RTU as in Step 3 below. 2a. Ensure RTU is properly inserted in patient. 2b. Press REPEAT soft key. 3a. Replace the RTU. 3b. Press REPLACE soft key. 3c. Enter new RTU number. 3d. Press NEXT soft key to restart calibration cycle. 3e. Record on Device Return Form that RTU has been replaced, if applicable. 3f. Turn off Control Unit and call Urologix Customer Service. 4. Check that the RTU is properly positioned. 5. Reinsert RTU or inflate RTU
101	Calibration halted by the MDS sensor (101)	<ol style="list-style-type: none"> 1. Fiber optic connector may be improperly connected or contaminated. 2. MDS may not be properly inserted. 3. MDS may be defective. 4. Fiber optic cable may be broken. 	<ol style="list-style-type: none"> 1a. Disconnect and reconnect MDS optical fiber connector on patient connection cable. 1b. Press REPEAT soft key. 1c. If 1b does not solve problem, disconnect optical fiber connector and clean with isopropyl alcohol and swab. 1d. Reconnect MDS optical fiber connector on patient connector cable and press REPEAT soft key. 1e. If this doesn't work, go to Step 3 below. 2. Ensure that MDS is properly inserted in patient. 3a. Replace MDS. 3b. Press REPEAT soft key. 3c. Enter new MDS serial #. 3d. Press NEXT soft key. 3e. Record on Device Return Form that new MDS has been installed. 4. Turn off Control Unit. Call Urologix Customer Service.

#	Problem Message	Possible Causes	Action Steps
102	Calibration halted by the Coolant Pump (102)	<ol style="list-style-type: none"> 1. Disposable Coolant Bag did not reach proper pressure during air purge. 2. Coolant Bag not filled with water. 3. Coolant Bag not installed properly. 4. Coolant Bag not connected to MDS. 5. Coolant Bag leaking. 6. MDS may be obstructed. 	<ol style="list-style-type: none"> 1. Press REPEAT. 2. Check water level in Coolant Bag to ensure that it is filled with 100 cc of sterile water. Press REPEAT. 3. Ensure that Coolant Bag and sensor module assembly are properly installed on Control Unit. Press REPEAT. 4a. To ensure Coolant Bag is properly connected to MDS, press REPEAT. 4b. If none of the above steps resolves the error, replace the Coolant Bag, fill with water and press REPEAT. Record on Device Return Form that new Coolant Bag has been installed, and return to Urologix. 5. Replace Coolant Bag. Fill with 100cc sterile water and press REPEAT. Record on Device Return Form that new Coolant Bag has been installed, and return to Urologix. 6a. Replace MDS and press REPLACE. 6b. Enter new MDS serial #. Press NEXT to start calibration cycle. Record on Device Return Form that new MDS has been installed, and return to Urologix.
103	Calibration halted by the MDS antenna (103)	<ol style="list-style-type: none"> 1. Check all previous 100, 101, 102 error causes first. 2. Antenna connector may be improperly connected. 3. Ensure that the urine drainage lumen has been purged. 4. MDS may be defective. 	<ol style="list-style-type: none"> 1. Check possible causes in error categories 100, 101, 102 and follow action steps. 2a. Reattach the connector. 2b. Press REPEAT. 3. Purge urine drainage lumen. 4a. Replace MDS if device fails to calibrate. 4b. Press REPLACE. 4c. Enter new MDS serial #. Press NEXT. 4d. Record on Device Return Form that new MDS was installed, and return to Urologix.

#	Problem Message	Possible Causes	Action Steps
104	MW OFF button has been actuated (104)	1. MW OFF soft key pressed accidentally. 2. Microwave indicator illuminated when it should not have been.	1. If key pressed accidentally, restart calibration sequence. 2. Press MAIN soft key and turn off Control Unit. Call Urologix Customer Service.
105	User pressed the Cancel soft key (105)	1. CANCEL soft key accidentally pressed. 2. Calibration stopped by user.	1. If key pressed accidentally, restart calibration sequence. 2. Address reason for stopping calibration and resume calibration sequence.
201	Invalid time (201)	1. Time is not in a valid format.	1. Enter time in a valid format.
202	Invalid date (202)	1. Date is not in a valid format.	1. Enter date in a valid format.
203	Disk write error (203)	1. Floppy disk is corrupt.	1. Use a new floppy disk.
204	Track formatting error (204)	1. Floppy disk is corrupt.	1. Use a new floppy disk.
205	Insufficient disk space (205)	1. Floppy disk is full.	1. Copy to a new floppy disk.
206	Couldn't create target file (206)	1. Floppy disk is write protected. 2. Floppy disk is corrupt.	1. Remove the write protect tab and retry. 2. If error reoccurs, use a new floppy disk.
207	I/O error during copy (207)	1. Floppy disk is not in drive.	1. Place floppy disk in drive.
208	Paper empty (208)	1. Printer is out of paper.	1. Load paper into the printer.
209	Printer time-out (209)	1. Printer has malfunctioned.	1. Do not continue to use the Control Unit. Call Urologix Customer Service.
210	Print head up (210)	1. Printer head is up.	1. Close the printer head.
211	Source file not found (211)	1. Control Unit cannot find the selected file.	1. Do not continue to use the Control Unit. Call Urologix Customer Service.
212	Invalid drive specified (212)	1. Control Unit cannot find the hard disk.	1. Do not continue to use the Control Unit. Call Urologix Customer Service.
216	Program will proceed with English files Language (216)	1. Language Disk was not loaded. 2. Hard drive failure.	1. Reload language. 2. Call Urologix Customer Service.

Troubleshooting

Section 5

#	Problem Message	Possible Causes	Action Steps
300	AMBIENT (300)	<ol style="list-style-type: none"> Control Unit vents are blocked on the sides or back of the machine. Control Unit internal temperature > 60°C. 	<ol style="list-style-type: none"> Remove any item that may be blocking the vents. <ol style="list-style-type: none"> Restart system at previous microwave power setting. Allow coolant system to run for five minutes in the halted screen and call Urologix Customer Service.
301	HOTSIDE PELTIER (301)	<ol style="list-style-type: none"> Peltier temperature sensor failed. Peltier hot side temperature reached upper temperature limit. 	<ol style="list-style-type: none"> 1 & 2. Allow coolant system to run for five minutes in the halted screen and call Urologix Customer Service.
302	COLDSIDE PELTIER (302)	<ol style="list-style-type: none"> Peltier temperature sensor has failed. Peltier element has reached low temperature limit. 	<ol style="list-style-type: none"> 1 & 2. Allow coolant system to run for five minutes in the halted screen and call Urologix Customer Service.
303	HARDWARE FAILSAFE MALFUNCTION (303)	<ol style="list-style-type: none"> Control Unit electronics have failed. 	<ol style="list-style-type: none"> Do not continue to use the Control Unit. Call Urologix Customer Service.
304	REGISTER SENSOR ADDRESS (304)	<ol style="list-style-type: none"> Control Unit electronics have failed. 	<ol style="list-style-type: none"> Do not continue to use the Control Unit. Call Urologix Customer Service.
305	MW MODULE INTERFACE (305)	<ol style="list-style-type: none"> Microwave amplifier or Control Unit electronics have failed. 	<ol style="list-style-type: none"> Do not continue to use the Control Unit. Call Urologix Customer Service.
306	INTERNAL SENSOR INTERFACE (306)	<ol style="list-style-type: none"> Control Unit electronics have failed. 	<ol style="list-style-type: none"> Do not continue to use the Control Unit. Call Urologix Customer Service.
307	MW HARDWARE (307)	<ol style="list-style-type: none"> Microwave amplifier has failed. Power ramped too quickly. 	<ol style="list-style-type: none"> 1 & 2. Do not continue to use the Control Unit. Call Urologix Customer Service.
308	RTU INTERFACE (308)	<ol style="list-style-type: none"> Control Unit electronics have failed. 	<ol style="list-style-type: none"> Do not continue to use the Control Unit. Call Urologix Customer Service.
309	SYNTHESIZER UNLOCKED (309)	<ol style="list-style-type: none"> Microwave amplifier has failed. 	<ol style="list-style-type: none"> Do not continue to use the Control Unit. Call Urologix Customer Service.
310	HARD DRIVE FAILURE (310)	<ol style="list-style-type: none"> Control Unit drive has failed. 	<ol style="list-style-type: none"> Do not continue to use the Control Unit. Call Urologix Customer Service.

Section 5**Troubleshooting**

#	Problem Message	Possible Causes	Action steps
311	FILE OPEN (311)	1. Control Unit hard drive failed.	1. Do not continue to use the Control Unit. Call Urologix Customer Service.
312	LX COMMUNICATION (312)	1. MDS temperature electronics failed.	1. Do not continue to use the Control Unit. Call Urologix Customer Service.
313	MW COMMUNICATION (313)	1. Microwave generator failed.	1. Do not continue to use the Control Unit. Call Urologix Customer Service.
314	ILLEGAL RETURN VALUE (314)	1. Control Unit software failed.	1. Do not continue to use the Control Unit. Call Urologix Customer Service.
315	WATCHDOG TIMEOUT (315)	1. Control Unit software failed.	1. Do not continue to use the Control Unit. Call Urologix Customer Service.
316	HARD DRIVE FULL (316)	1. Control Unit hard drive full.	1. Do not continue to use the Control Unit. Call Urologix Customer Service.
317	HWFS FAILSAFE DISABLED (317)	1. Hardware failsafe disabled. 2. Low voltage at start-up. 3. Power loss or surge. 4. Extension cord used.	1 - 4. Do not continue to use the Control Unit. Call Urologix Customer Service.
318	MW SOFTWARE (318)	1. Microwave generator failed. 2. Low voltage at start-up. 3. Power loss or surge. 4. Extension cord used.	1 - 4. Do not continue to use the Control Unit. Call Urologix Customer Service.
319	HWFS DISCONNECTED (319)	1. Control Unit electronics failed.	1. Do not continue to use the Control Unit. Call Urologix Customer Service.
320	MW SUPPLY (320)	1. Microwave generator power supply failed.	1. Do not continue to use the Control Unit. Call Urologix Customer Service.
321	RAM PARITY (321)	1. RAM parity check failed.	1. Do not continue to use the Control Unit. Call Urologix Customer Service.
322	PROGRAM INTEGRITY (322)	1. CRC failed.	1. Do not continue to use the Control Unit. Call Urologix Customer Service.

Troubleshooting

Section 5

#	Problem Message	Possible Causes	Action Steps
323	ENGLISH LANGUAGE FILE (323)	1. A problem was found with the English language file.	1. Do not continue to use the Control Unit. Call Urologix Customer Service.
324	MDS WARMUP ERROR (324)	1. MDS temperature electronics failed.	1. Do not continue to use the Control Unit. Call Urologix Customer Service.
325	MDS HEATER FAILURE (325)	1. MDS temperature electronics failed.	1. Do not continue to use the Control Unit. Call Urologix Customer Service.
326	MDS FAILURE (326)	1. MDS temperature electronics failed.	1. Do not continue to use the Control Unit. Call Urologix Customer Service.

Section 5

Troubleshooting

5.2. Targis Treatment Screens

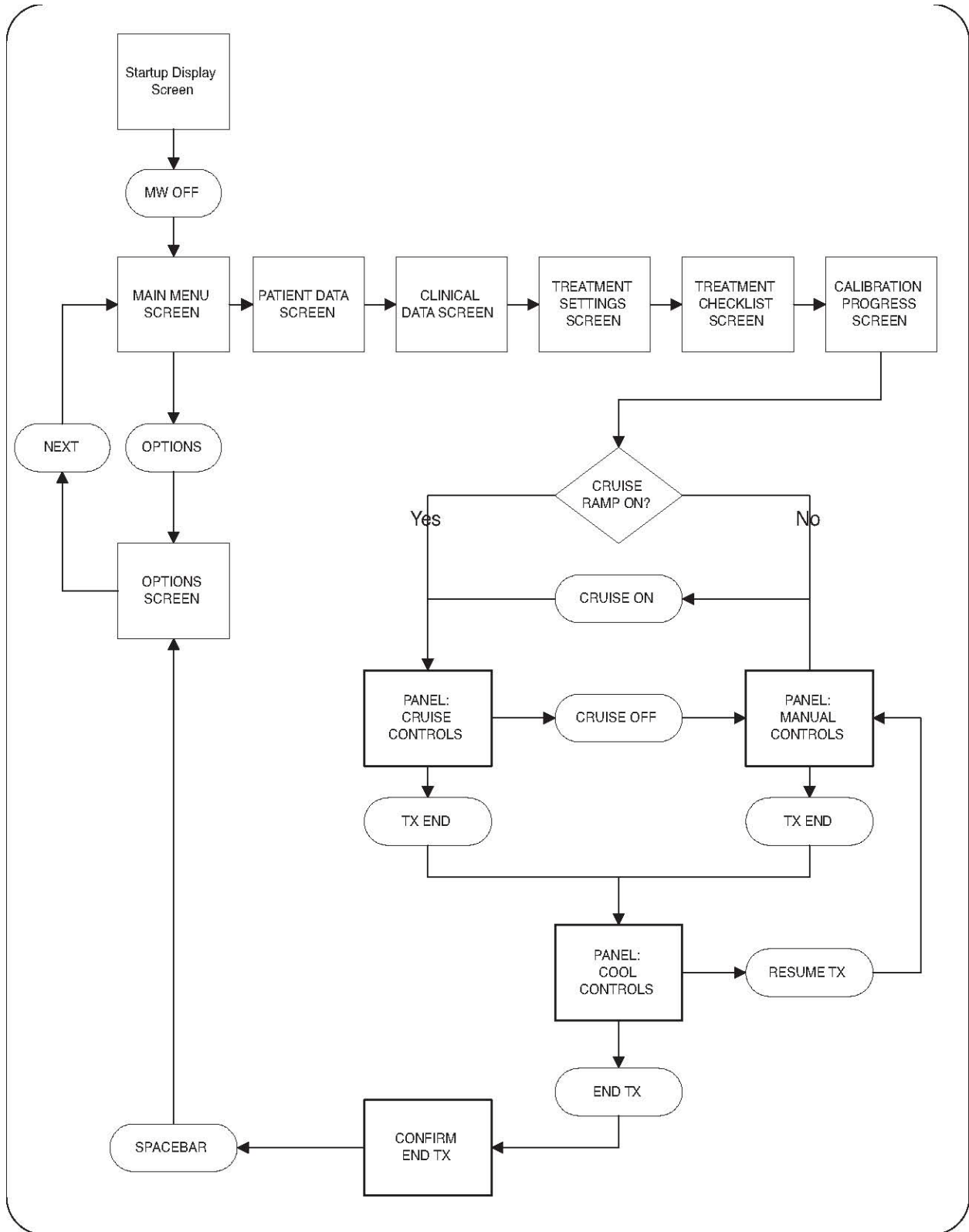









Troubleshooting

Section 5



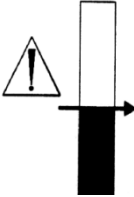





5.3 Description of Symbols



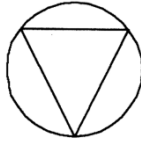
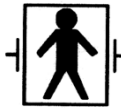



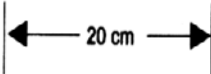
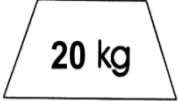

There are a number of symbols associated with the Targis System: Targis Control Unit, Microwave Catheter, RTU and Coolant Bag. Some of these symbols appear in Section 1 of this manual. Other symbols Urologix adopted from the international community to assist you in understanding Urologix labeling.

Symbol	Description
	Alternating current
	Catalog Number
	Batch Code / Lot Number
	Serial Number
	Do not re-use
	Equal potential ground
	Fuse type and value
	Internal reservoir level
	Nonionizing radiation (microwave power)
	Operate on a level surface
RTU	Rectal unit

Section 5

Troubleshooting

Symbol	Description
	Consult Instructions for Use
	Caution
	Stop microwave energy
	Type BF equipment with defibrillation protection
	Sterilized Using Ethylene Oxide
	Use By Date
	Temperature Limitation
	Do Not Resterilize
	Recyclable Package
	Keep objects 20 cm from vents
	Do not place heavy objects on drawer

Symbol	Description
	<p>Caution cold surface</p>
	<p>Do Not Use if Package is Damaged</p>
<p>Rx ONLY</p>	<p>Caution: Federal (U.S.A.) law restricts this device to sale by or on the order of a physician trained and/or experienced in the use of this device as outlined in the required training program</p>
	<p>Note</p>
	<p>Caution</p>
	<p>Warning</p>
	<p>Date of Manufacture</p>
	<p>Manufacturer</p>
	<p>Authorized Representative in the European Community</p>

5.4. Glossary

Analgesia

The reduction of pain stimulus without the corresponding loss of consciousness.

Analgesic

A medication that reduces or eliminates pain. In BPH patients, depending on the clinician's diagnosis, there are several agents that might be considered for the reduction of pain.

Antibiotic

A substance that is used to destroy or inhibit the growth of microorganisms.

Anti-inflammatory

A medication that is used to reduce inflammation, which is often characterized by localized heat, redness, swelling, and pain in the tissues.

ASCII Format

A unique computer code associated with a particular function and key on the keyboard of the Targis Control Unit.

Benign Prostatic Hyperplasia (BPH)

A nonmalignant but abnormal increase in the tissue of the prostate gland that sometimes results in constriction of the urethra.

BPH

The acronym for Benign Prostatic Hyperplasia.

Calibration Process

A diagnostic test that the Targis Control Unit runs to determine whether its components are functioning properly: (1) Rectal unit and temperature sensors are operating within 2°C of each other; (2) Urethra temperature sensor is operational; (3) Pressure in the microwave cooling system is normal; and (4) Antenna is operational, as verified by a frequency sweep.

Catheterization

The placement of the Microwave Catheter or urine drainage catheter into the urethra.

Chill Plate

One of the components of the Targis Control Unit Coolant System that removes heat from the Coolant Bag.

Coolant Bag

The Coolant Bag is comprised of 3 main subassemblies: coolant bag (coolant reservoir), sensor module, and tubing with connectors. The Coolant Bag is a container that fits against the chill plate. It is filled with sterile, distilled water (coolant) that circulates through the Microwave Catheter during treatment to preserve urethral tissue.

Coolant Door

The large front panel of the Targis Control Unit behind which is located the Coolant System.

Coolant Pump

See peristaltic pump mechanism.

Coolant Set Point

The temperature at which the cooling system is set to regulate the temperature of the water circulating through the Microwave Catheter. The actual water temperature may be different from this value during the time that the system chills or warms the water. Once the water reaches the coolant set point value, the coolant temperature is maintained within a small tolerance of this value.

Coolant System

The Coolant System consists of a chill plate, temperature and pressure sensors, a peristaltic pump mechanism, and a Coolant Bag.

Coolant Temperature

The actual measured temperature of the water circulating through the Microwave Catheter. This temperature is measured at the sensor block just before the water leaves the Control Unit.

Coolant Down

The coolant down button (soft key) allows the user to decrease the coolant set point by 1°C.

Coolant Up

The coolant up button (soft key) allows the user to increase the coolant set point by 1°C.

Cooldown

The time in a treatment when the microwave power is OFF, the coolant pump is running, and the Cooldown 5-minute timer appears.

Cooled ThermoCath Microwave Catheter

A type of Microwave Catheter.

Cooled ThermoTherapy Procedure

A medical procedure that uses microwave energy to destroy the prostatic tissue that constricts the urethra while preserving urethral function and tissue.

Cooling Channel

The tiny passageways, adjacent to the antenna within the Microwave Catheter, that transport chilled, sterile water throughout the catheter to maintain a urethra temperature.

Cooling Lumen

See cooling channel.

Computer Subsystem

The Targis Control Unit contains a computer that allows the clinician to input patient identification data, control the treatment session and collect treatment data.

CTC Advance Microwave Catheter

A type of Microwave Catheter.

Display Screen

The thermoplastic viewing surface of the Targis Control Unit that allows the clinician to view information related to a patient's prostate treatment.

Ejaculation

The discharge of semen through the penis during sexual excitement.

Exclusion criteria

A list of conditions that may bar a prospective patient from participating in a BPH clinical trial.

Floppy Disk

A portable 3.5 inch storage medium where the patient's files are stored. It is inserted in the floppy disk drive on the right side of the Targis Control Unit keyboard.

Floppy Disk Drive

The computer device that reads and writes information on the patient's floppy (portable) disk. The floppy disk drive is located on the right side of the Targis Control Unit keyboard.

Frequency Sweep

An internal diagnostic test the Control Unit performs to determine the functional status of the microwave antenna once it is placed inside the patient.

Gross Hematuria

A profuse quantity of blood in the urine.

Hospital or Clinic ID

The patient's medical record number.

Impotence

The inability to achieve an erection.

Incontinence

The inability to control urination.

Interval Timer

The mechanism in the Targis Control Unit that displays the time at which the last power adjustment occurred.

Location Balloon

The inflatable portion of the Microwave Catheter found near the tip that locates the microwave antenna within the bladder/bladder neck.

MDS

An acronym for Microwave Delivery System, also refers to the Microwave Catheter.

MDS Temp

The temperature at the tip of the Targis Microwave Catheter in the center of the treatment region.

Messages

Directions or reports that assist the clinician in monitoring a Cooled ThermoTherapy procedure.

Microwave Antenna

The Targis System component within the Microwave Catheter that generates heat energy to destroy prostate tissue.

Microwave Catheter Balloon

See location balloon.

Microwave Catheter Holder

The Microwave Catheter Holder is designed to hold the Microwave Catheter in position during treatment.

Microwave Catheter Serial Number

The serial number of the Microwave Catheter used in a treatment and required for the patient's data file.

Microwave Delivery System / Microwave Catheter /MDS

A disposable, catheter-based device (which is delivered sterile) that is inserted into the urethra. It includes a fiber optic temperature sensor to measure urethral temperature, a microwave antenna and cable, cooling channels and connectors, a urine drainage port that connects to a standard urine drainage bag, and a location balloon to position the catheter at the bladder neck.

Microwave Power Down

The microwave power down button (soft key) on the Control Unit monitor that decreases the power set point by one watt.

Microwave Power Off

The microwave power off button on the Control Unit monitor that allows you to discontinue the delivery of the microwave power immediately.

Microwave Power Up

The microwave power up button (soft key) on the Control Unit monitor that increase the power set point by one watt.

MW

An abbreviation for microwave.

Neurogenic Bladder

Dysfunctional urinary bladder caused by a lesion of the nervous system.

Obstructive Bladder Neck Syndrome

An impairment of the outlet area of the bladder caused by prostate tissue constricting the urethra.

Orientation Flag

The vertical guide on the disposable rectal unit, approximately 1" in height that serves the clinician in correctly positioning the rectal balloon.

Patient Comfort Kit

A Targis Control Unit accessory which includes 2 knee cushions and Microwave Catheter Holder. It provides comfort for the patient and holds the catheter in position for the duration of treatment.

Patient Connection Cable

An extension cable that connects the patient connection cable housing to the Targis Control Unit.

Patient Connection Cable Housing

The patient connection cable housing contains connectors for the rectal unit, fiber optic connector, and microwave connector.

Perineum

An anatomical landmark between the scrotum and the anus.

Peristaltic Pump Mechanism

The small, wheel-like motorized drive behind the coolant door of the Targis Control Unit that uses peristaltic action to propel coolant through the coolant inlet tubing to the Microwave Catheter and beyond. Also referred to as the coolant pump.

Power Set Point

Represents the actual microwave power output exactly equal to the power setting within the accuracy limits of the Targis Control Unit.

Preprostatic Urethra

The proximal portion of the prostatic urethra. It runs through the prostate beginning just distal to the bladder neck and ending just proximal to the verumontanum.

Pressure Sensor

The small polyurethane disk that fits against the diaphragm of the sensor module on the lower right front side of the Targis Control Unit. Its function is to detect changes in pressure within the tubing of the Microwave Catheter and signal potential coolant leaks.

Procedure Kit

The Procedure Kit contains 1 disposable Microwave Catheter, 1 disposable Rectal Thermosensing Unit, and 1 Coolant Bag.

Prostate Gland

A partly muscular, partly glandular organ that surrounds the neck of the bladder and the urethra. It secretes an alkaline viscose fluid that provides maintenance and activation of sperm at ejaculation.

Prostatic Median Lobe

The middle rounded mass of 3 rounded masses of tissue that develop adjacent to the urethra in the hyperplastic prostate.

Prostatism

Disease of the prostate gland.

Pump Mechanism

The small wheel-like motorized drive behind the coolant door of the Targis Control Unit that uses peristaltic action to propel coolant through the inlet tubing to the Microwave Catheter and beyond. This is part of the coolant system.

Pump Tubing Clamp

The fastening arm just above the peristaltic pump mechanism that locks the coolant inlet tubing in place as it is routed out of the Control Unit console to the Microwave Catheter.

Rectal Temperature

The temperature reported by the warmest of the 5 sensors in the rectal unit.

Rectal Thermosensing Unit / (RTU) / Rectal Unit

A device with temperature sensors that monitors the patient's rectal temperatures when the device is positioned correctly within the rectum along the rectal prostatic wall. It is connected to the patient connection cable, via the patient connection cable housing, of the Targis Control Unit.

Rectum

The terminal portion of the intestine (continuation of the sigmoid colon) that ends in the anus.

Retrograde Ejaculation

Sometimes called "dry climax," this event refers to the discharge of semen backwards into the bladder. The condition may result from surgery that cuts the muscle that blocks the entrance to the bladder.

RTD

An acronym for Resistive Temperature Detector.

RTU

A single-use rectal unit, and an acronym for what was previously referred to as the Rectal Thermosensing Unit.

RTU Plus

The rectal unit with a reusable handle and single-use balloon.

RTU Serial Number

The serial number of the Rectal Thermosensing Unit used in a treatment and required for the patient's data file.

Self-Test Cycle

The Targis Control Unit's internal checking procedure, which runs each time the system is turned on.

Soft Keys

Four vertically positioned keys next to the Targis Control Unit display screen that allow the clinician to control the procedure session.

Targis Microwave Catheter

A type of Microwave Catheter.

Temperature Sensor

A device within the Microwave Catheter that monitors the urethral temperature of the patient; or a device within the rectal unit that monitors the rectal temperature of the patient.

Testes

The male reproductive glands that reside in the scrotum and produce spermatozoa. Interstitial cells in the testes secrete a hormone, an androgen, that aids the growth and development of the prostate gland.

Transport Kit

The only FDA-approved method, other than the original shipping crate, for transporting a Targis Control Unit. It includes a trolley and electrical safety tester.

Transrectal Ultrasound (TRUS)

Procedure where a clinician inserts a probe into the rectum to obtain an image of the prostate. This image appears on the display to assist the clinician in placing a biopsy needle. Also used to determine prostate size.

Transurethral Incision of the Prostate (TUIP)

A surgical procedure that widens the urethra by making small cuts in the prostate and the bladder neck where the bladder and urethra join.

Transurethral Resection of the Prostate (TURP)

A surgical procedure that involves the removal of tissue from the interior of the prostate with an instrument called a resectoscope.

Treatment Monitor

The housing that sits on top of the Targis Control Unit, including the display screen that allows the clinician to view information related to a patient's prostate treatment.

Treatment Parameters

Targis System values, such as the Microwave Catheter and the rectal temperatures, that the clinician monitors during treatment.

Treatment Protocol

The step-by-step plan the clinician follows when treating the patient's prostate condition. Or, the set of treatment parameters clinicians choose to treat a patient's prostate condition.

Troubleshooting

Section 5

Treatment Session

A treatment session begins when the patient enters the clinic and ends when the treatment is over and he is discharged.

Treatment Timer

The mechanism in the Targis Control Unit that advances increments of seconds and minutes at therapeutic temperature.

TRUS

An acronym for transrectal ultrasound.

TUIP

An acronym for transurethral incision of the prostate.

TURP

An acronym for the transurethral resection of the prostate.

Universal Precautions Guidelines

A standard set of safeguards that apply to patients undergoing treatment. For example, the Targis Control Unit should not be moved while the electrical cord is connected to a power source.

Urethra Set Point

The urethra temperature the Control Unit maintains during a treatment. The system increases or decreases microwave power until it reaches the urethra set point.

Urethra Temperature

The temperature at the tip of the Microwave Catheter in the center of the treatment region.

Urinary Tract

The pathway in the urogenital system that urine travels as it is eliminated from the body. It consists of the renal tubules and pelvis of the kidney, the ureter, the bladder, and the urethra.

Urination

Discharge of liquid waste from the body.

Verumontanum

An elevation in the floor of the prostate gland where it joins the urethra and the entrance of the seminal ducts.

Electromagnetic Compatibility (EMC) Tables

5.5 Electromagnetic Compatibility (EMC) Tables

Guidance and manufacturer’s declaration - Electromagnetic Emissions		
The Targis Control Unit is intended for use in the electromagnetic environment specified below. The customer or the user of the Targis Control Unit should assure that it is used in such an environment.		
Emissions Test	Compliance	Electromagnetic Environment - Guidance
RF emissions CISPR 11	Group 2	The Targis Control Unit must emit electromagnetic energy in order to perform its intended function. Nearby electronic equipment may be affected.
RF emissions CSPR 11	Class A	The Targis Control Unit is suitable for use in all establishments other than domestic and may be used in domestic establishments and those directly connected to the public low-voltage power supply network that supplies building used for domestic proposes, provided that the following warning is heeded: Warning: This equipment is intended for use by healthcare professionals only. This equipment/system may cause radio interference or may disrupt the operation of nearby equipment. It may be necessary to take mitigation measures such as re-orienting or relocating the Targis Control Unit or shielding the location.
Harmonic emissions IEC 61000-3-2	Class A	
Voltage fluctuations/ flicker emissions IEC 61000-3-3	Complies	

Table 5-1 Electromagnetic Emissions

Guidance and manufacturer's declaration - Electromagnetic Immunity			
The Targis Control Unit is intended for use in the electromagnetic environment specified below. The customer or the user of the Targis Control Unit should assure that it is used in such an environment.			
Immunity test	IEC 60601 test level	Compliance level	Electromagnetic Environment - Guidance
Electrostatic discharge (ESD) IEC 61000-4-2	±6 kV contact ±8 kV air	±6 kV contact ±8 kV air	Floors should be wood, concrete, or ceramic tile. If floors are covered with synthetic material, the relative humidity should be at least 30%
Electrical fast transient/burst IEC 61000-4-4	±2 kV for power supply lines ±1 kV for input/output lines	±2 kV for power supply lines ±1 kV for input/output lines	Mains power quality should be that of a typical commercial or hospital environment.
Surge IEC 61000-4-5	±1 kV line(s) to line(s) ±2 kV line(s) to earth	±1 kV line(s) to line(s) ±2 kV line(s) to earth	Mains power quality should be that of a typical commercial or hospital environment.
Voltage dips, short interruptions and voltage variations on power supply input lines IEC 61000-4-11	<5% U_T (>95% dip in U_T) for 0.5 cycle <40% U_T (>60% dip in U_T) for 5 cycles <70% U_T (>30% dip in U_T) for 25 cycles <5% U_T (>95% dip in U_T) for 5 s	<5% U_T (>95% dip in U_T) for 0.5 cycle <40% U_T (>60% dip in U_T) for 5 cycles <70% U_T (>30% dip in U_T) for 25 cycles <5% U_T (>95% dip in U_T) for 5 s	Mains power quality should be that of a typical commercial or hospital environment. If the user of the Targis Control Unit requires continued operation during power mains interruptions, it is recommended that the Targis Control Unit be powered from an uninterruptible power supply or a battery.
Power frequency (50/60 Hz) magnetic field IEC 61000-4-8	3 A/m	3 A/m	Power frequency magnetic fields should be at levels characteristic of a typical location in a typical commercial or hospital environment.
NOTE U_T is an A.C. mains voltage prior to application of the test level			

Table 5-2 Electromagnetic Immunity

Guidance and manufacturer’s declaration - Electromagnetic Immunity			
The Targis Control Unit is intended for use in the electromagnetic environment specified below. The customer or the user of the Targis Control Unit should assure that it is used in such an environment.			
Immunity Test	IEC 60601 Test Level	Compliance Level	Electromagnetic Environment - Guidance
Portable and mobile RF communications equipment should be used no closer to any part of the Targis Control Unit, including cables, than the recommended separation distance calculated from the equation applicable to the frequency of the transmitter.			
			Recommended separation distance
Conducted RF IEC 61000-4-6	3 Vrms 150 kHz to 80 MHz	3V	$d = 1.2\sqrt{P}$
Radiated RF IEC 61000-4-3	3 V/m 80MHz to 2.5 GHz	3V/m	$d = 1.2\sqrt{P}$ 80MHz to 800 MHz $d = 2.3\sqrt{P}$ 800MHz to 2.5GHz
Where P is the maximum output power rating of the transmitter in watts (W) according to the transmitter manufacturer and d is the recommended separation distance in meters (m). Field strength from fixed RF transmitters, as determined by an electromagnetic site survey*, should be less than the compliance level in each frequency range.** Interference may occur in the vicinity of equipment marked with the following symbol: 			
Note 1. At 80 MHz and 800 MHz, the higher frequency range applies Note 2. These guidelines may not apply in all situations. Electromagnetic propagation is affected by absorption and reflection from structures, objects and people.			
* Field strengths from fixed transmitters, such as base stations for radio (cellular/cordless) telephones and land mobile radios, amateur radio, AM and FM radio broadcast and TV broadcast cannot be predicted theoretically with accuracy. To assess the electromagnetic environment due to fixed RF transmitters, and electromagnetic site survey should be considered. If the measured field strength in the location in which the Targis Control Unit is used exceeds the applicable RF compliance level above, the Targis Control Unit should be observed to verify normal operation. If abnormal performance is observed, additional measures may be necessary, such as re-orienting or relocating the Targis Control Unit.			
** Over the frequency range 150 kHz to 80 MHz, field strengths should be less than 3 V/m			

Table 5-3 Electromagnetic Immunity (continued)

Recommended separation distance between portable and mobile RF communications equipment and the Targis Control Unit			
The Targis Control Unit is intended for use in an electromagnetic environment in which radiated RF disturbances are controlled. The customer or the user of the Targis Control Unit can help prevent electromagnetic interference by maintaining a minimum distance between portable and mobile RF communications equipment (transmitters) and the Targis Control Unit as recommended below, according to the maximum output power of the communications equipment.			
Rated maximum output power of transmitter (W)	Separation distance according to frequency of transmitter (m)		
	150 kHz to 80 MHz $d = 1.2\sqrt{P}$	80 MHz to 800 MHz $d = 1.2\sqrt{P}$	800 MHz to 2.5 GHz $d = 2.3\sqrt{P}$
0.01	0.12	0.12	0.23
0.1	0.38	0.38	0.73
1	1.2	1.2	2.3
10	3.8	3.8	7.3
100	12	12	23
<p>For transmitters rated at a maximum output power not listed above, the recommended separation distance d in meters (m) can be estimated using the equation applicable to the frequency of the transmitter, where P is the maximum output power rating of the transmitter in watts (W) according to the transmitter manufacturer.</p> <p>Note 1. At 80 MHz and 800 MHz, the separation distance for the higher frequency range applies.</p> <p>Note 2. These guidelines may not apply in all situations. Electromagnetic propagation is affected by absorption and reflection from structures, objects and people.</p>			

Table 5-4 Recommended Separation Distances

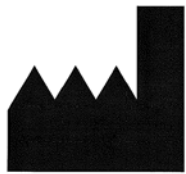

Urologix, Inc.
14405 Twenty First Avenue North
Minneapolis, MN 55447-4640
(763) 475-1400 Phone
(800) 475-1403 Toll-free
(763) 475-1443 Fax
(888) 229-0772 Toll-free 24-hour customer service
www.urologix.com



Emergo Europe
Molenstraat 15
2513 BH The Hague
The Netherlands



Targis System: Targis Control Unit User Manual - Part #250209-001 Rev K, June 2015
© 2015 Urologix, Inc. All rights reserved. Printed in the USA.